

**normann**  
C O P E N H A G E N

**Norm 06** Large

**SAMLEINSTRUKTION**  
**MONTERINGSINSTRUKTIONER**  
**MONTERINGSINSTRUKSJONER**  
**ASSEMBLY INSTRUCTIONS**  
**MONTAGEANLEITUNG**  
**INSTRUCTIONS D'ASSEMBLAGE**  
**INSTRUCCIONES DE MONTAJE**  
**ISTRUZIONI DI MONTAGGIO**  
**MONTAGE-INSTRUCTIES**  
**INSTRUÇÕES DE MONTAGEM**  
**組み立て方**  
**조립 안내**

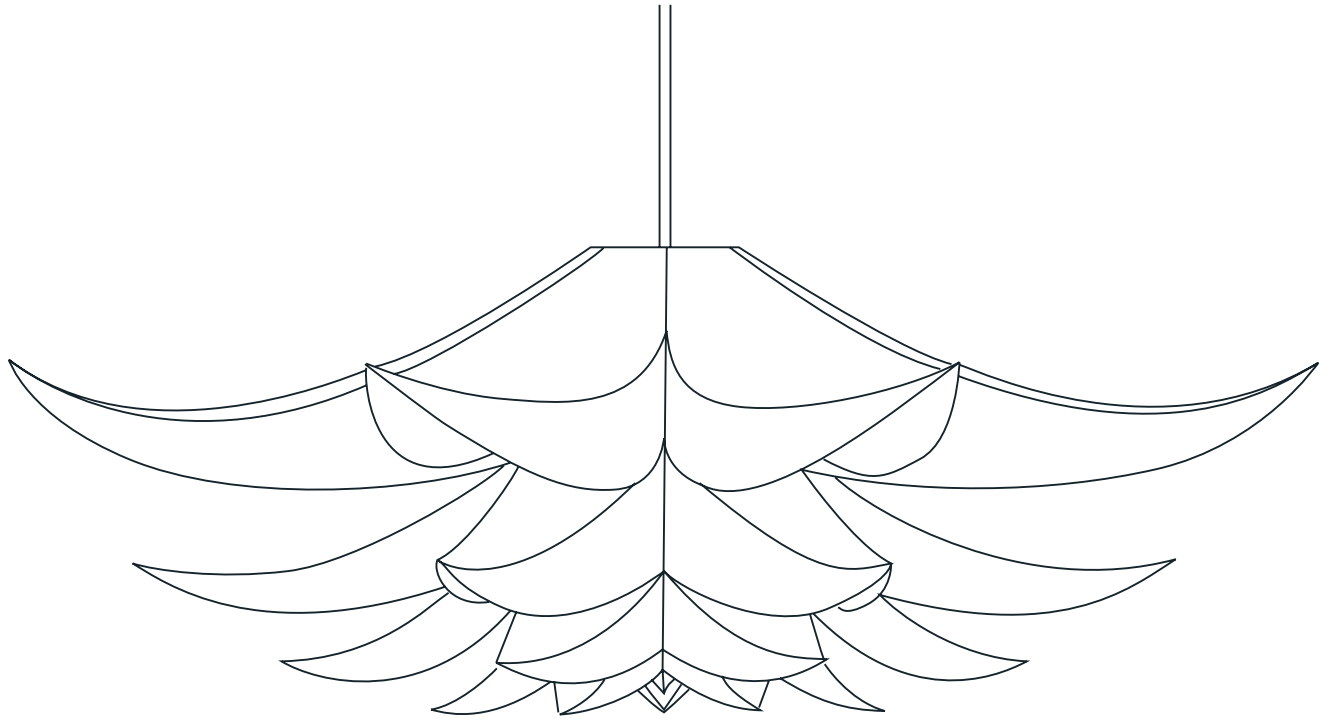

**Norm 06 Large**



Indhold:

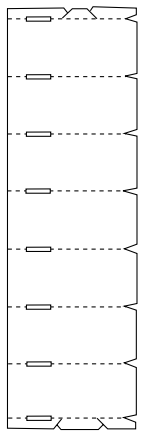

1 sokkelement

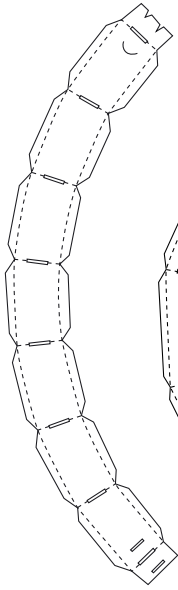

1 ringelement S

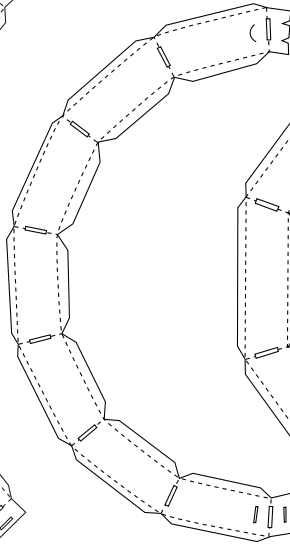

1 ringelement M

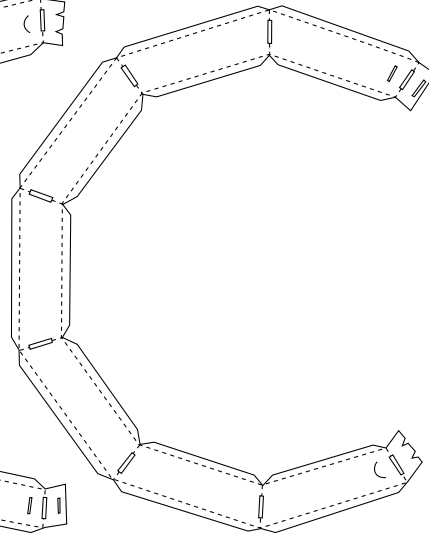

1 ringelement L

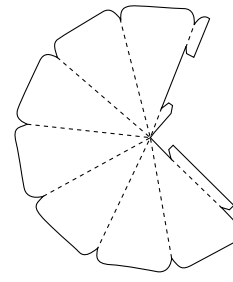

1 bundmodul

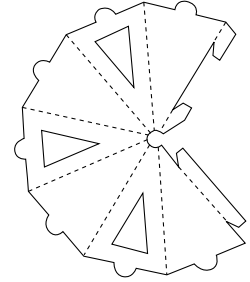

1 ophængsmodul

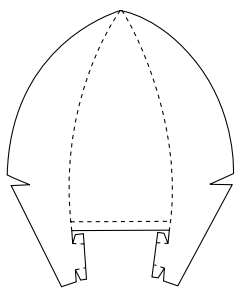

7 skærmelementer nr. 1

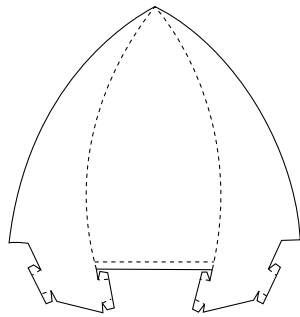

7 skærmelementer nr. 2

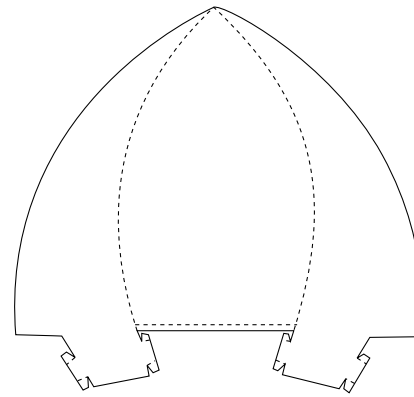

7 skærmelementer nr. 3

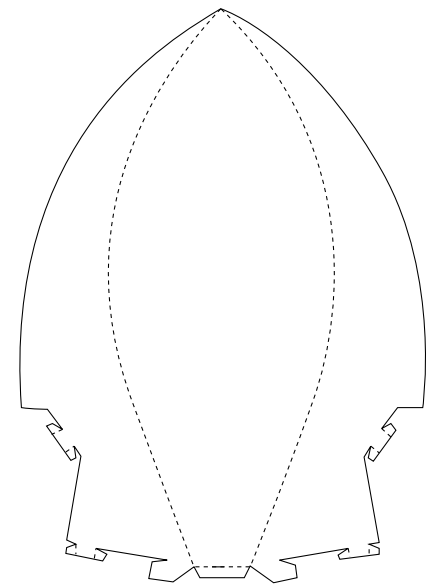

7 skærmelementer nr. 4

Samleinstruktion:

I.

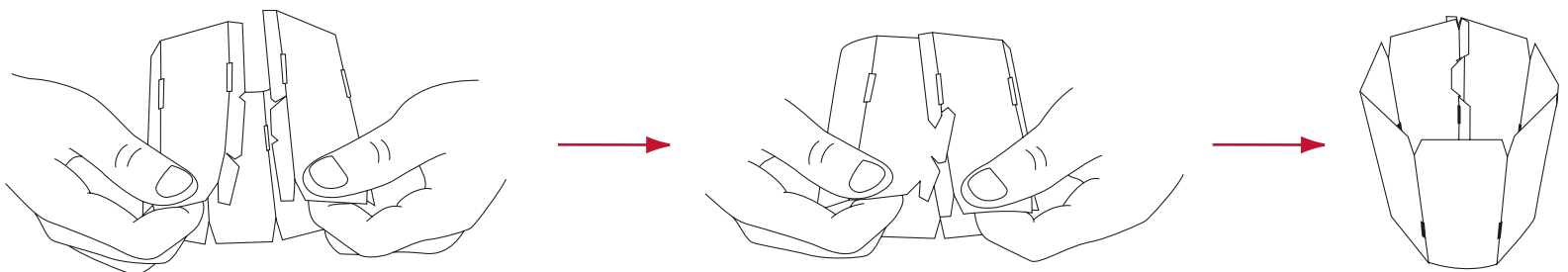

Soklen 'knipses' sammen til en 7-kantet cylinder med den matte side udad.

2.

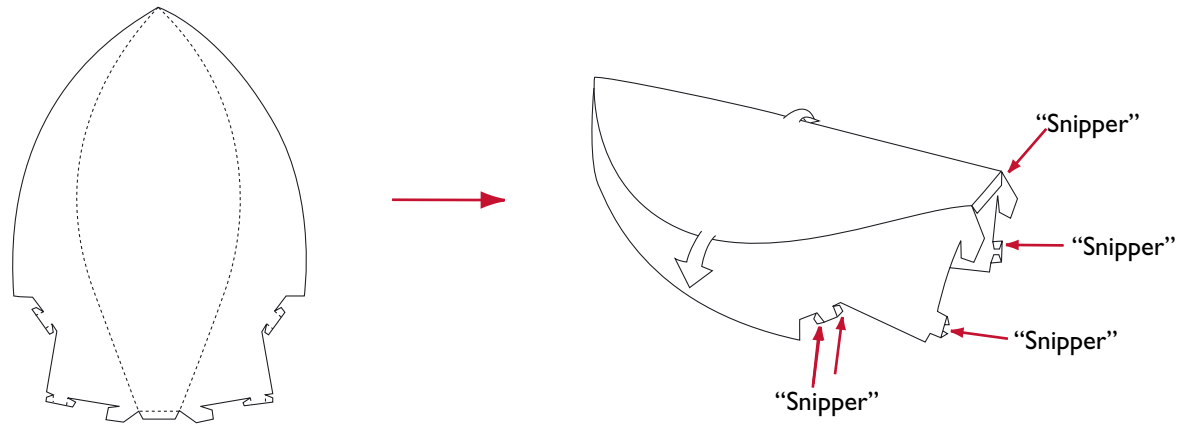

De 7 skærmelementer mærket "4" foldes som vist. Ombøj forsigtigt der hvor skærmelementet buer.

"Snipperne" bøjes ind, så den matte side vender udaf.

3.

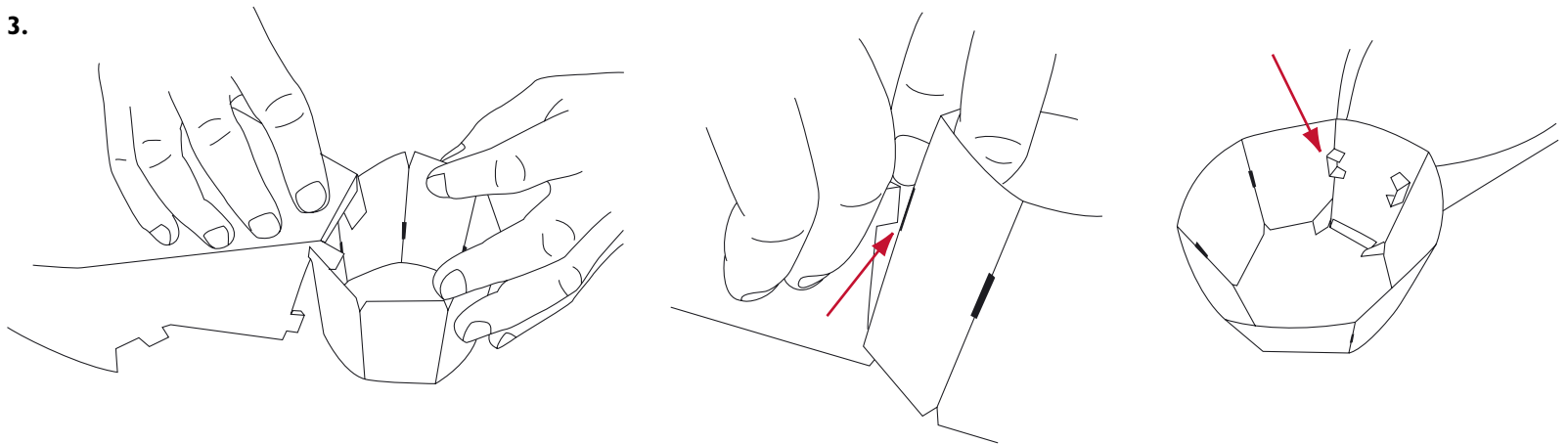

Skærmelementet haspes på den smalle del af åbningen på sokkelementet.

Vend sokkelementet på hovedet og før 'snipperne' igennem hullerne og ombøj 'snipperne' på bagsiden, så modulet er låst.

4.

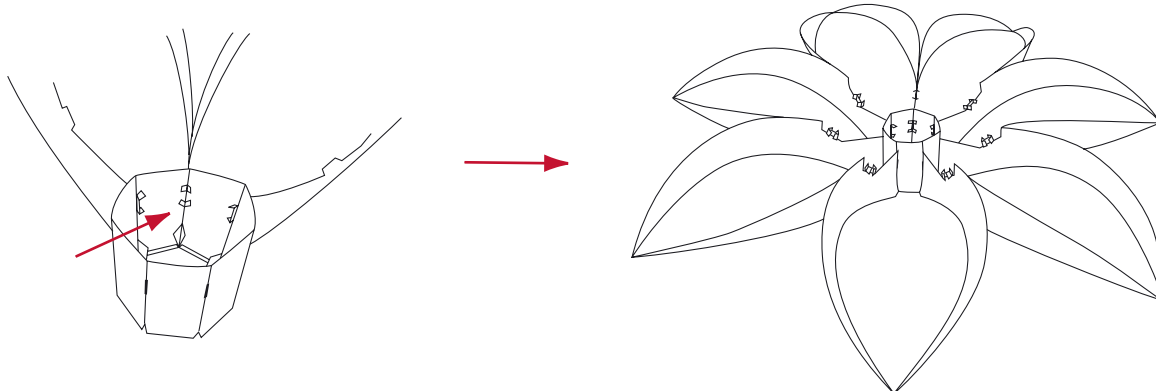

Sæt næste skærmelement på soklen ved siden af de første og fortsæt sådan, til alle 7 skærmelementer nr. 4 er monteret. Husk at låse modulerne på indersiden af soklen.

5.

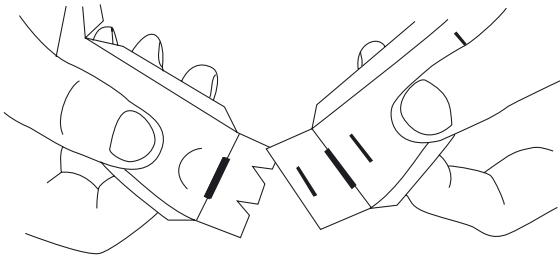

Tag ringelementet mærket "L" og ombøj forstærkningskanterne. Saml ringelementet ved hjælp af 'snipperne'.

6.

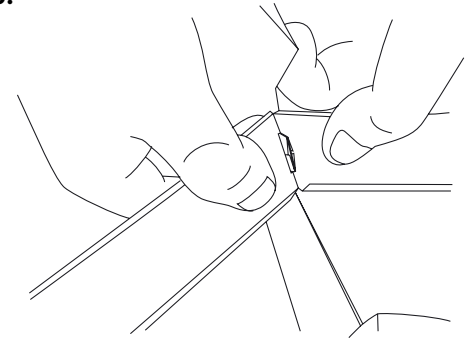

Monter ringelementet "L" på 'snipperne', der sidder på skærmelementet og lås dem ved at rette "snipperne" ud.

7.

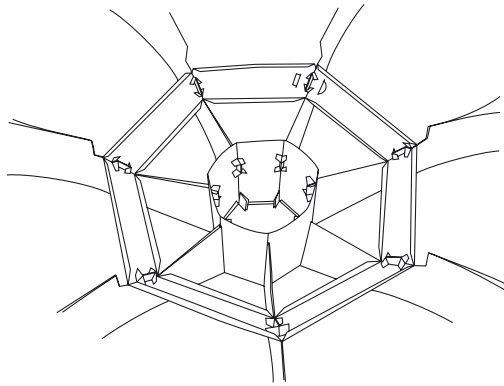

Ringelement korrekt fastmonteret.

8.

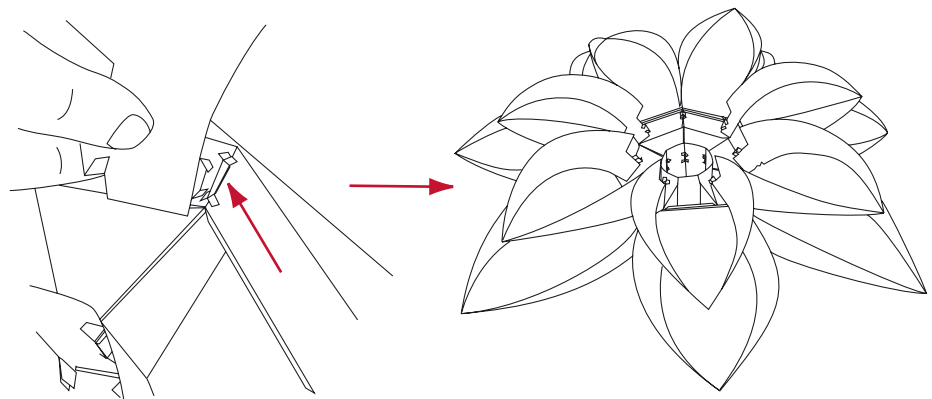

Fold de 7 skærmelementer mærket "3". Ombøj forsigtigt hvor skærmelementet buer. Monter første skærmelement på ringelementet ved at stikke 'snipperne' igennem hullet, hvor de andre 'snipper' også sidder.

Monter resten af skærmelementerne på samme måde hele vejen rundt. Husk at låse modulerne på bagsiden.

9.

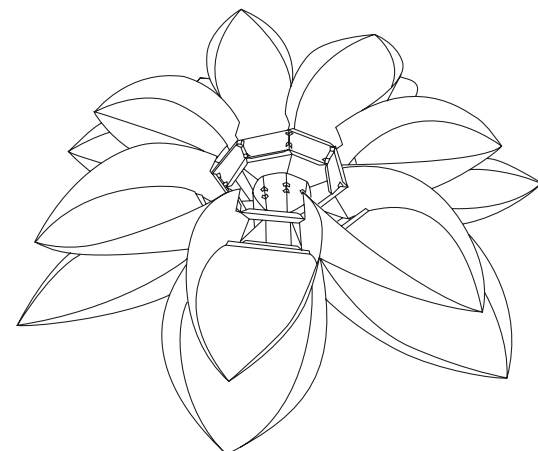

Saml og monter ringelement "M" på skærmelementerne mærket "3".

10.

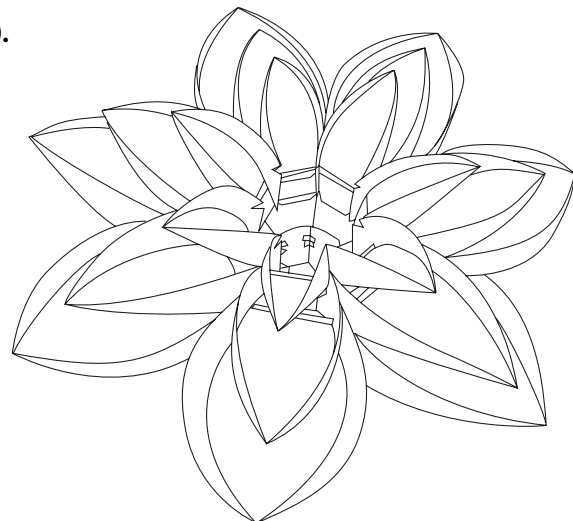

Fold skærmelementerne mærket "2" og monter dem på ringelement "M" hele vejen rundt. Monter ringelement "S".

11.

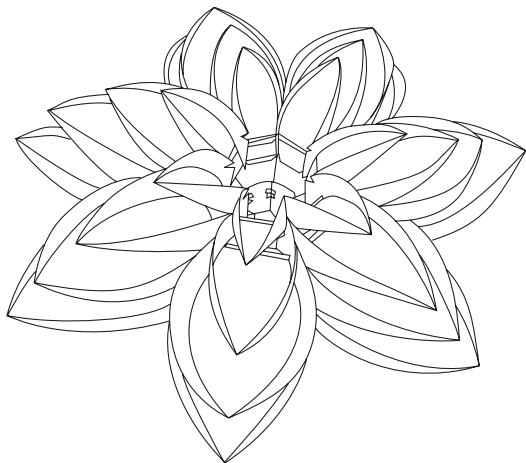

Fold de 7 skærmelementer mærket "I" og monter dem på ringelement "S" hele vejen rundt.

12.

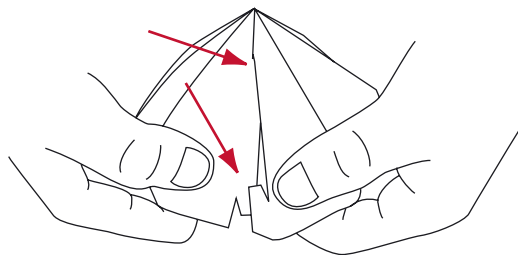

Bøj og saml bundmodulet. Sørg for at samlingen vender indad.

13.

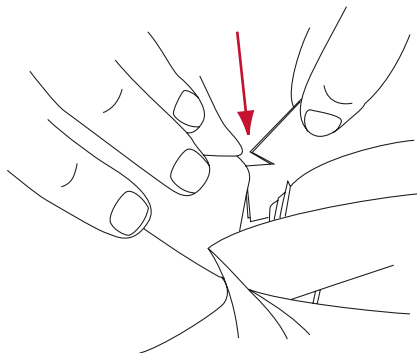

Monter bundmodulet i sliderne på de inderste skærmelementer. (Sliderne er de små hakker).

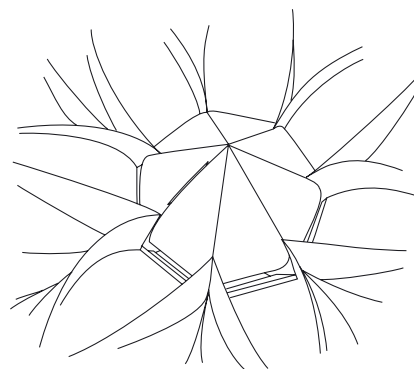

Færdigmonteret bundmodul.

14.

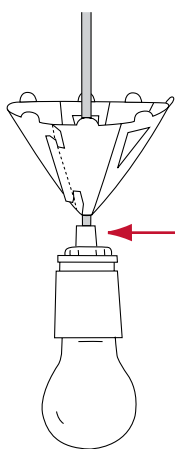

Bøj ophængsmodulet i de 6 led og saml det omkring ledningerne, så det har form som et 7-kantet kræmmerhus.

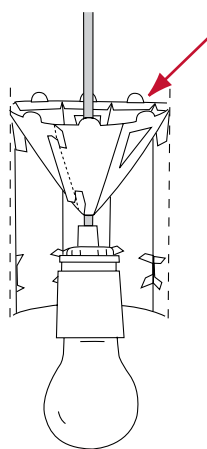

Vend lampen om så åbningen i lampens top vender opad. Sænk ophængsmodulet ned i åbningen og stik 'snipperne' i gennem hullerne. Bøj forstærkningskanterne ned i vandret, så det låser ophængsmodulet.

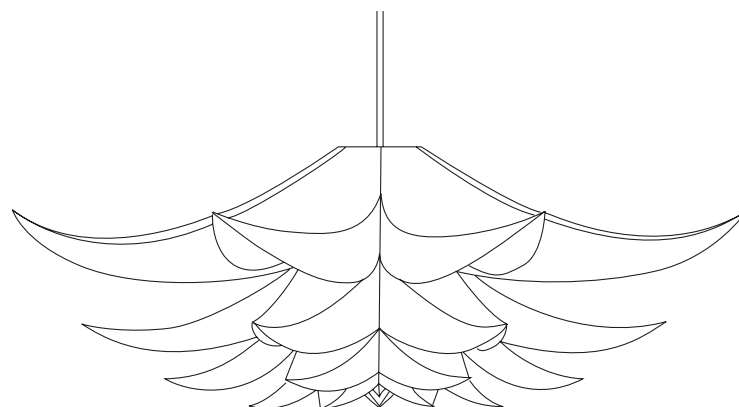

Færdigmonteret lampe klar til ophængning. Lampen kan hænges op uden at afmontere lampefatning. Udskiftning af pære kan nemt foretages gennem lampens fleksible bund.

**MAKS 60 WATT**



Innehåll:

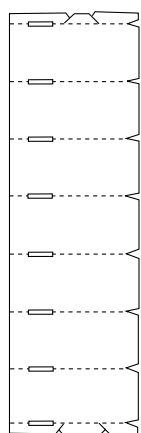

1 basenhet

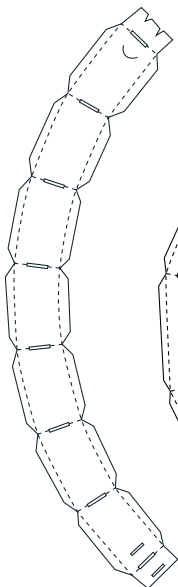

1 ringenhet S

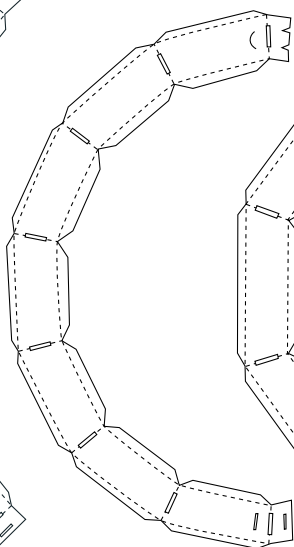

1 ringenhet M

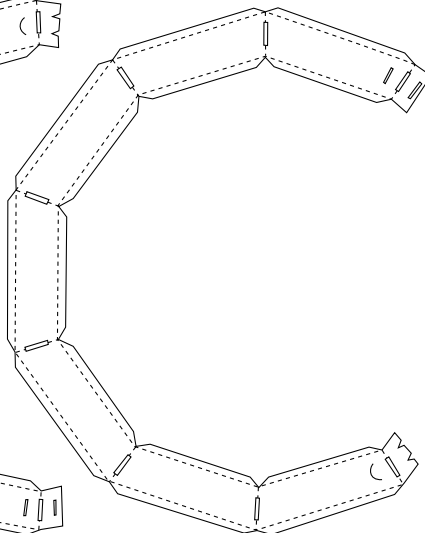

1 ringenhet L

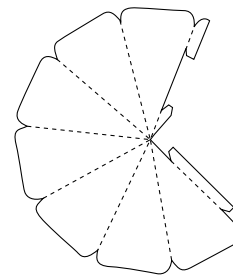

1 basmodul

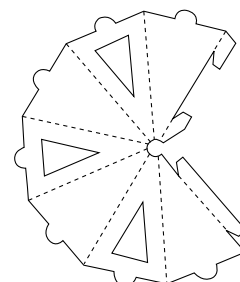

1 upphängningsmodul

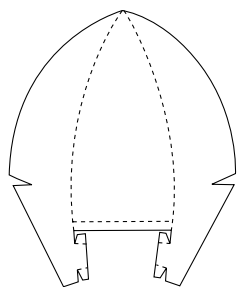

7 lampskärmsenheter 1

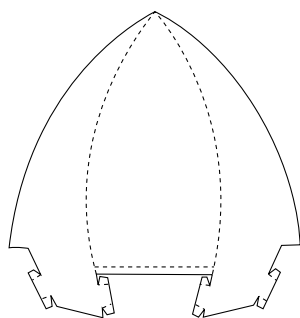

7 lampskärmsenheter 2

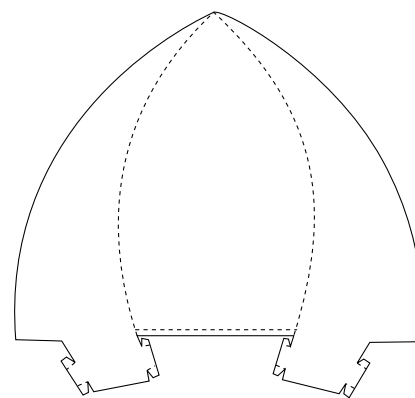

7 lampskärmsenheter 3

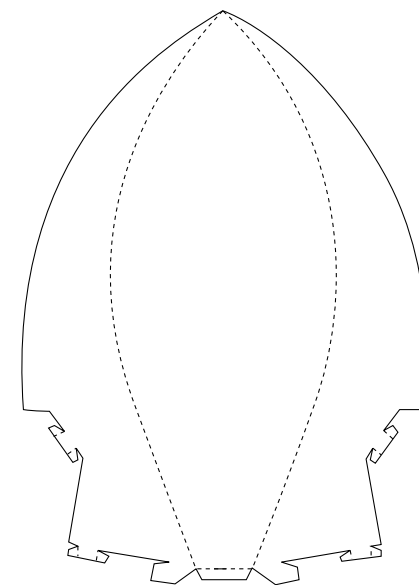

7 lampskärmsenheter 4

Monteringsinstruktioner:

I.

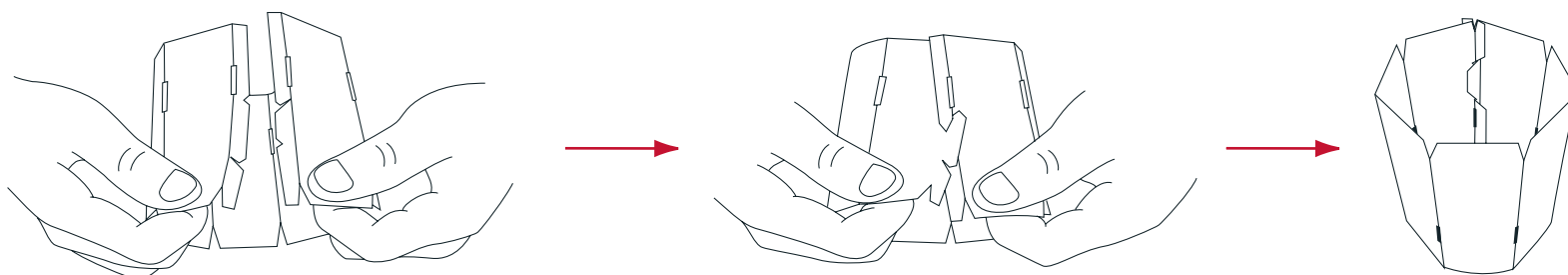

Sätt ihop basen till en 7-sidig cylinder med den matta sidan utåt.

## MONTERINGSINSTRUKTIONER TILL NORM 06 LARGE/SVENSKA

2.

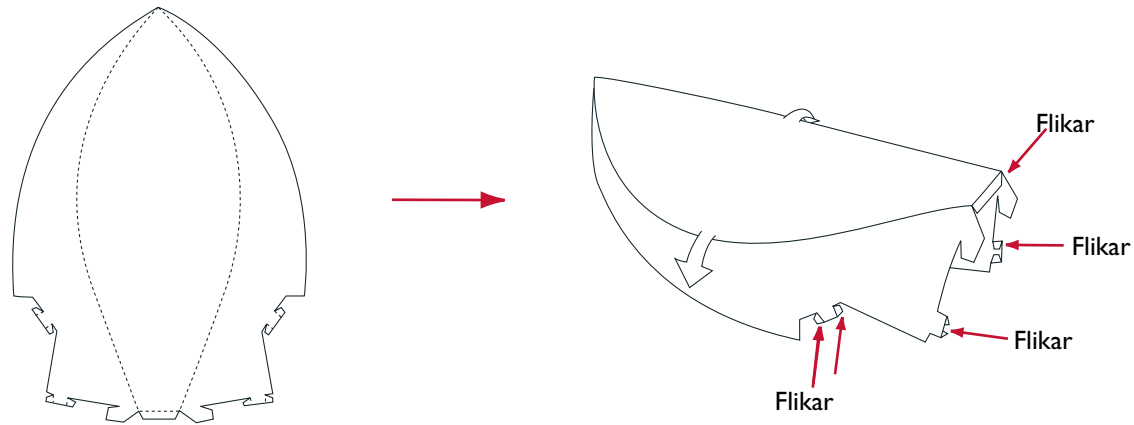

Vik de 7 lampskärmsenheterna markerade med "4" som visat. Vik försiktigt längs med skärmenhetens kurva.

Vik in flikarna med den matta sidan utåt.

3.

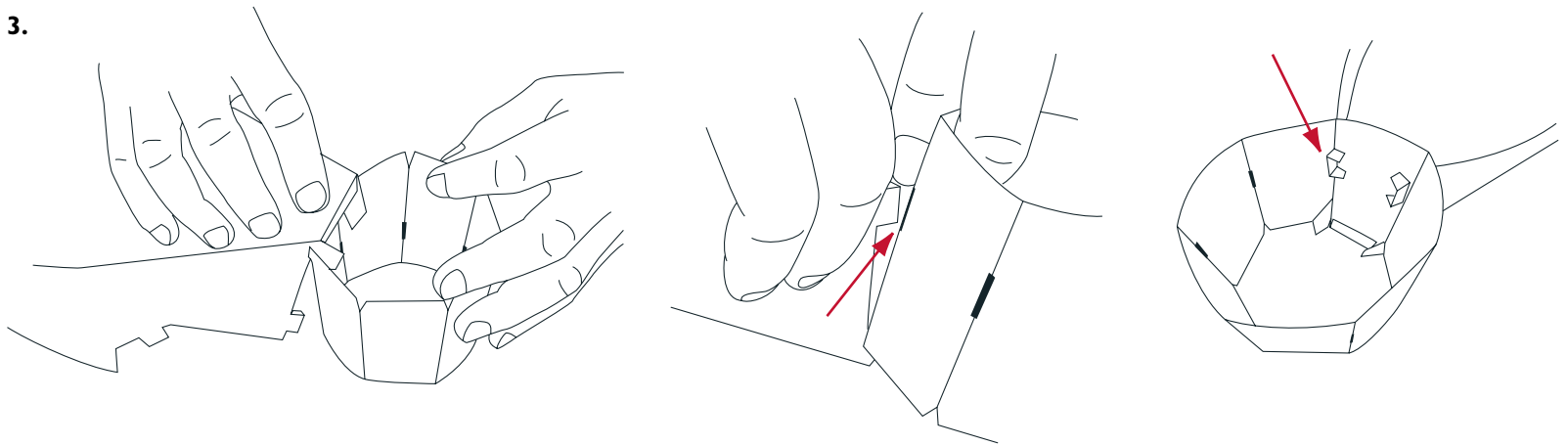

Haka fast skärmenheten till den smala delen av basenhetens öppning.

Vänd basenheten upp och ned och för flikarna genom hålen. Vik över dem på baksidan för att låsa modulen.

4.

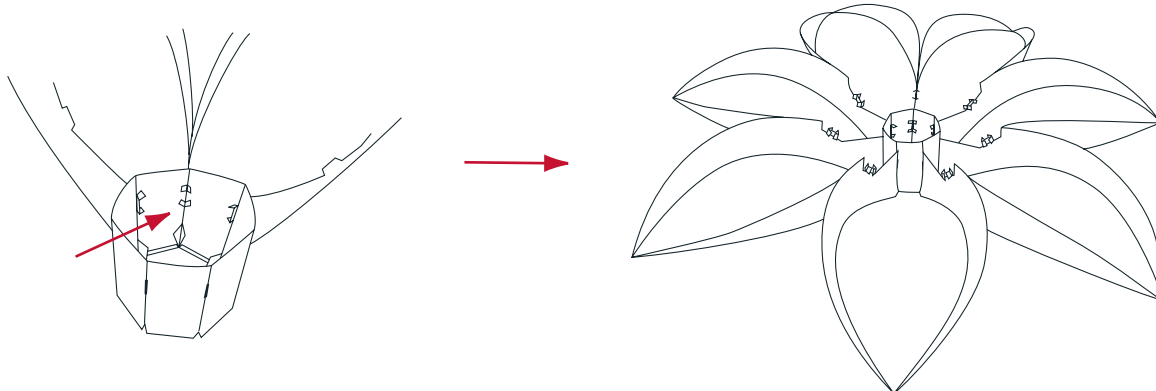

Placera nästa skärmenhet på basen intill den första och fortsätt tills alla 7 lampskärmsenheter markerade med "4" har monterats. Kom ihåg att låsa modulerna på basens insida.

5.

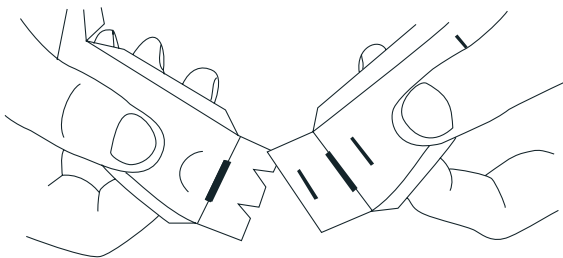

Ta ringenheten markerad med "L" och vik över de stärkande kanterna. Montera ringenheten genom att använda flikarna.

6.

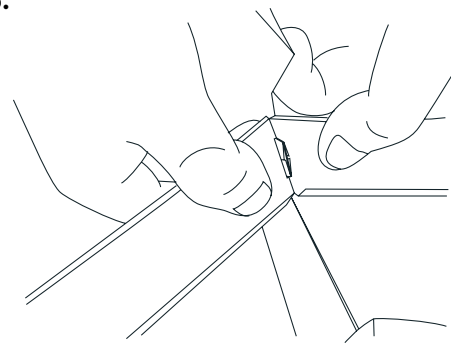

Montera ringenheten "L" på flikarna på lampskärmsenheten och lås dem genom att räta ut flikarna.

7.

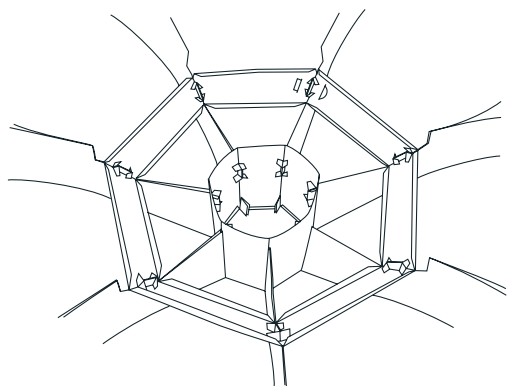

Korrekt monterad ringenhet.

8.

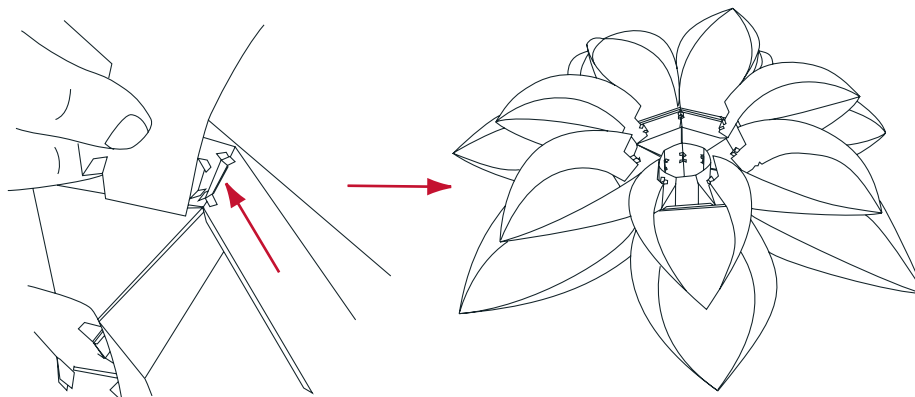

Vik de 7 lampskärmsenheterna markerade med "3". Vik försiktigt över längs med skärmenhetens kurva. Montera den första skärmenheten på ringenheten genom att föra flikarna genom hålet där de andra flikarna också är lokaliserade.

Montera resten av lampskärmsenheterna på liknande sätt hela vägen runt. Kom ihåg att låsa modulerna på baksidan.

9.

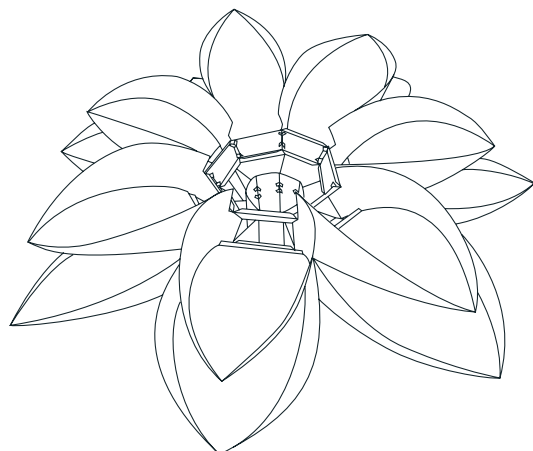

Sätt ihop och montera ringenhet "M" på lampskärmsenheterna markerade med "3".

10.

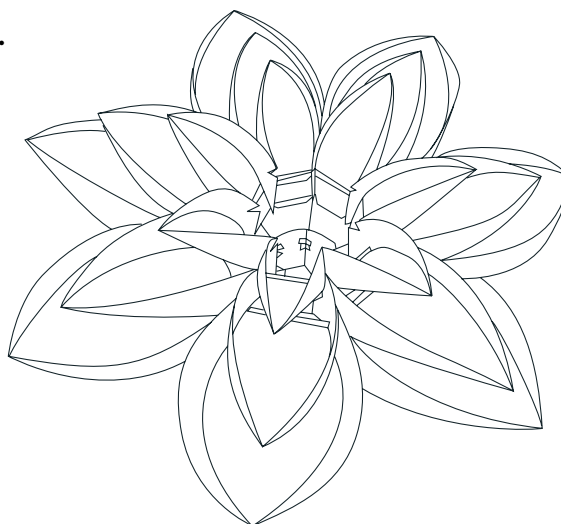

Vik lampskärmsenheterna markerade "2" och montera dem på ringenheten "M" hela vägen runt. Montera ringenhet "S".

## MONTERINGSINSTRUKTIONER TILL NORM 06 LARGE/SVENSKA

11.

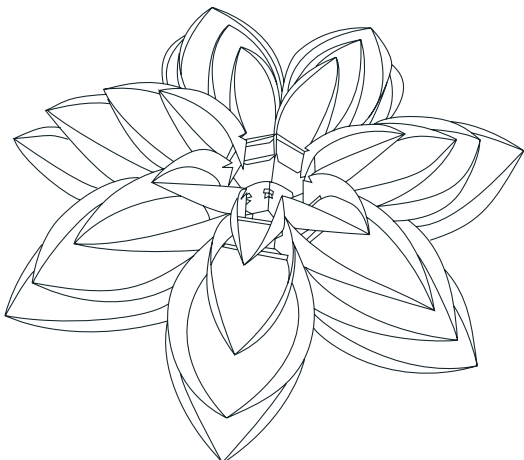

Vik de 7 lampskärmsenheterna markerade "I" och montera dem på ringenheten "S" hela vägen runt.

12.

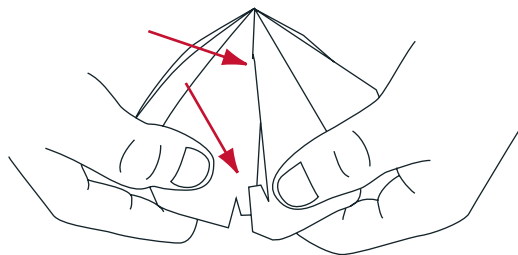

Böj och montera basmodulen.  
Säkerställ att skarvarna är vända inåt.

13.

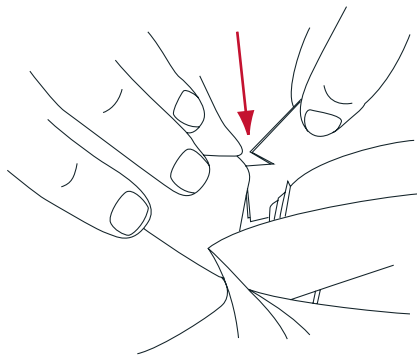

Fäst basmodulen i springorna på de inre lampskärmsenheterna. (Springorna är de små utskurna hålen.)

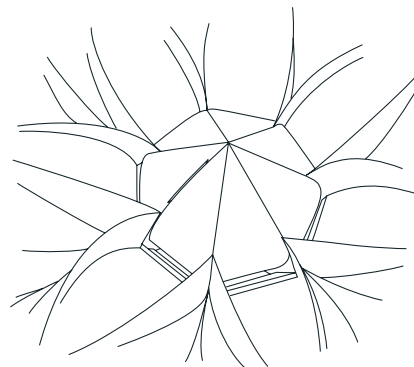

Den färdigmonterade basmodulen.

14.

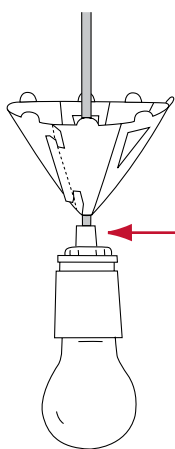

Klämnippeln **MÅSTE** vara monterad.

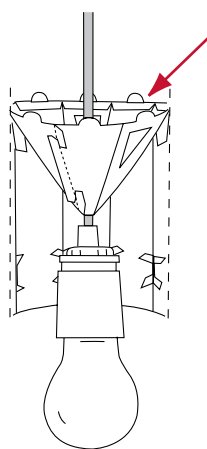

Böj upphängningsmodulen i de 6 riktningarna och montera runt vajrarna så att de formar en 7-sidig kon.

Vrid runt lampan så att öppningen på lampans topp vänds uppåt. Sänk upphängningsmodulen in i öppningen och för flikarna genom hålen. Vik ned de stärkande kanten horisontalt så att de låser upphängningsmodulen.

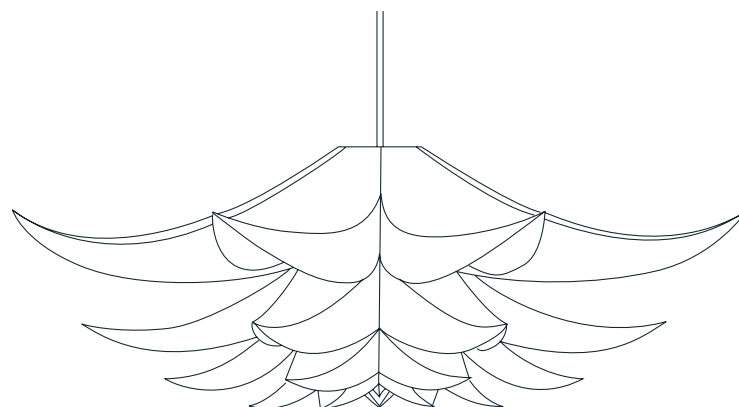

Den färdigmonterade lampan är redo att hängas upp. Lampan kan hängas upp utan att ta bort lamparmaturen. Glödlampor kan enkelt bytas genom lampans flexibla bas.

**MAX 60 WATT**

**Innhold:**

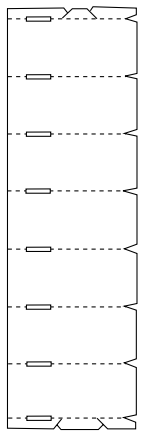

1 grunnelement

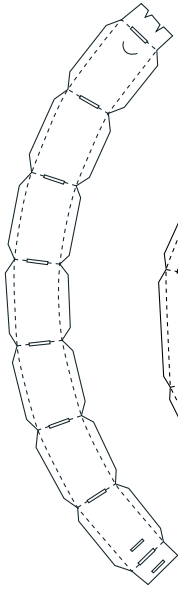

1 ringelement S

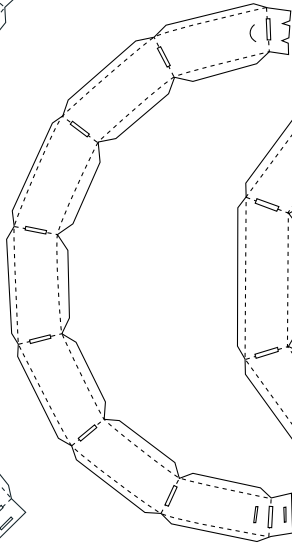

1 ringelement M

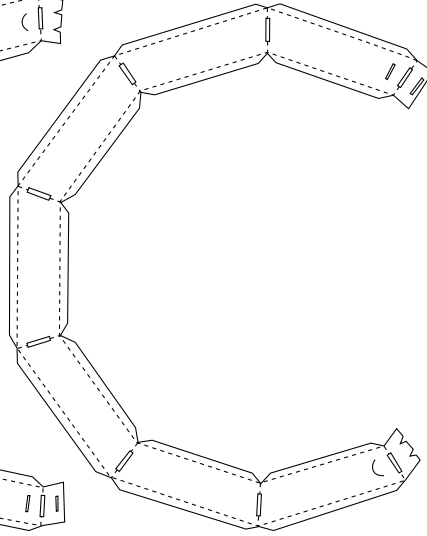

1 ringelement L

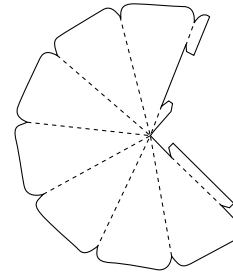

1 grunnmodul

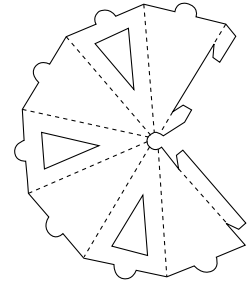

1 opphengingsmodul

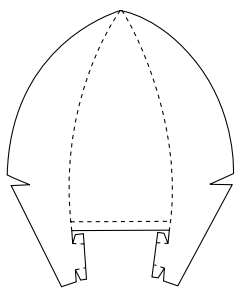

7 lampeskjermelementer, nr. 1

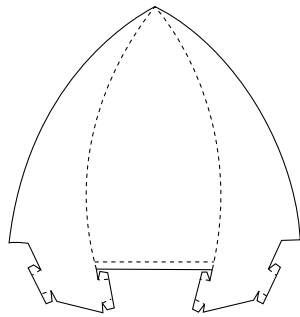

7 lampeskjermelementer, nr. 2

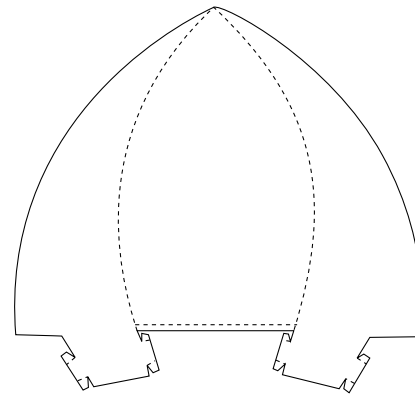

7 lampeskjermelementer, nr. 3

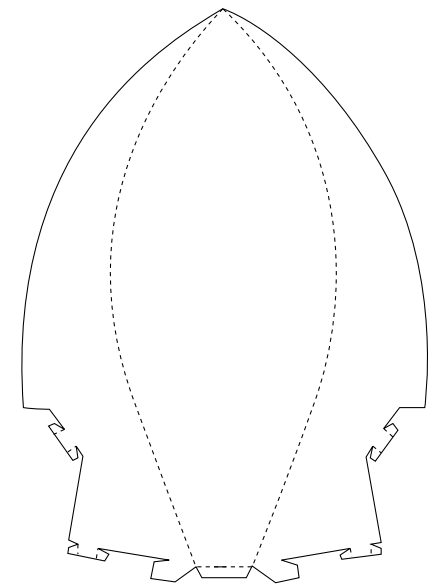

7 lampeskjermelementer, nr. 4

**Monteringsinstruksjoner:**

**I.**

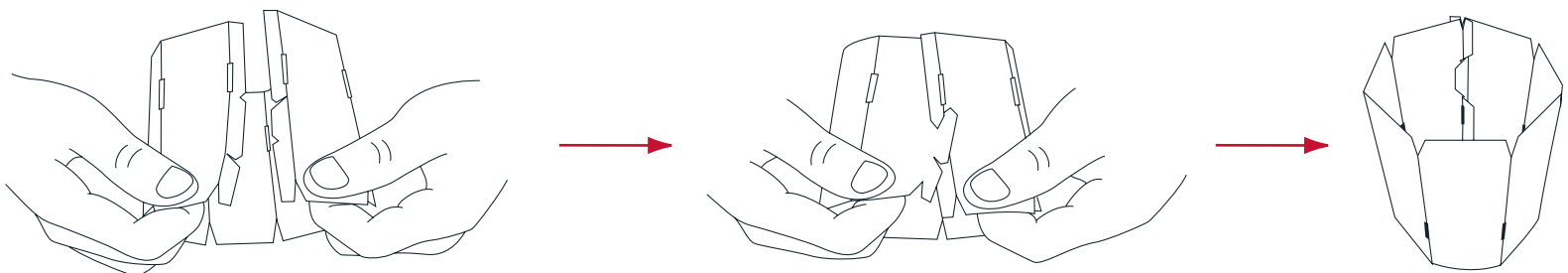

Klikk grunnelementene sammen til en sylinder med sju sider, med den matte siden ut.

2.

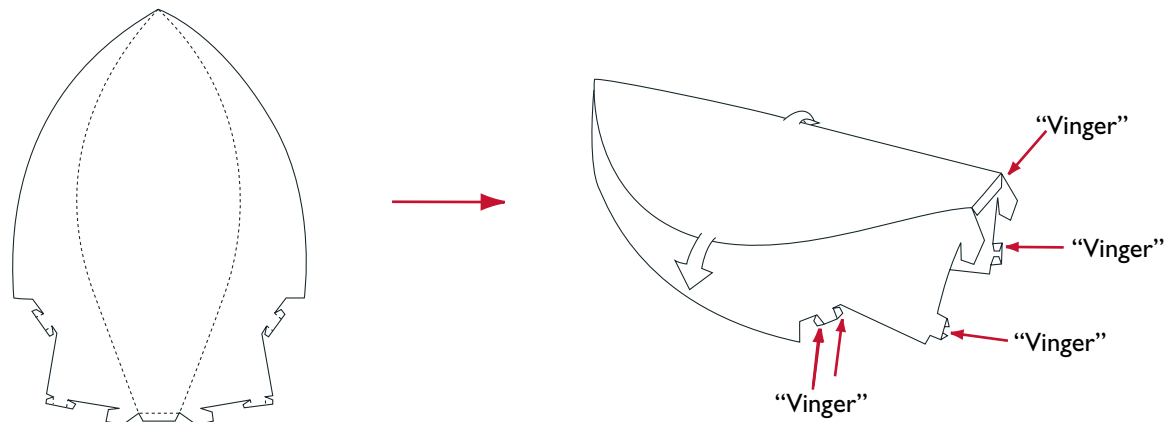

Brett de sju lampeskjermelementene merket 4, som vist. Brett forsiktig langs buen på skjermelementet.

Brett inn "vingene", slik at den matte siden vender ut.

3.

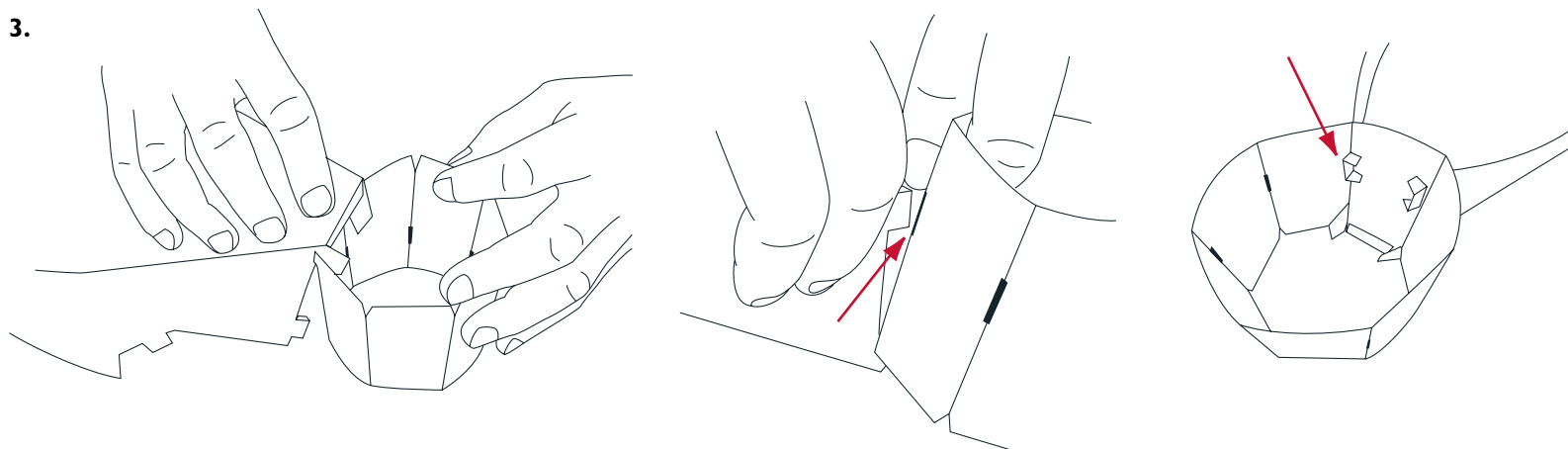

Hekt skjermelementet på den smale delen av åpningen på grunnelementet.

Snu grunnelementet opp-ned og før "vingene" gjennom hullene, brett dem over baksiden slik at modulen låses.

4.

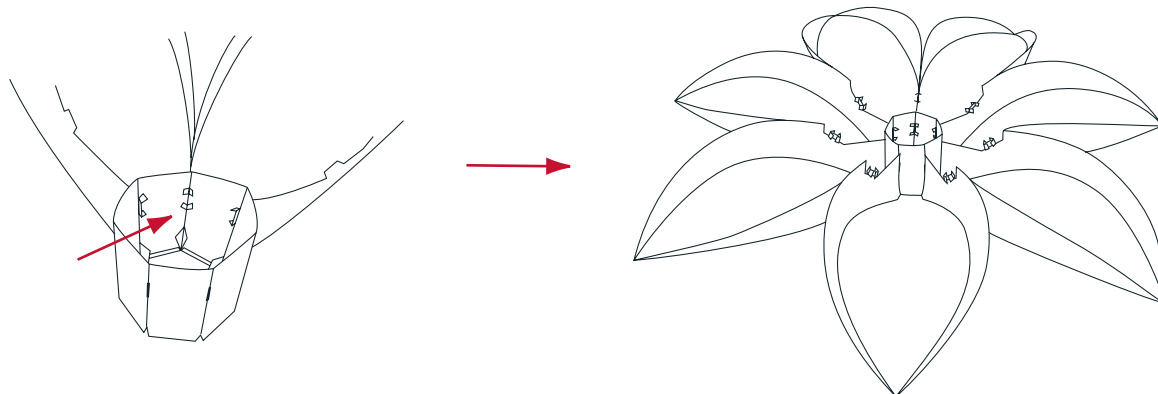

Sett det neste skjermelementet på grunn-elementet ved siden av det første, og fortsett til alle sju lampeskjermelementene, nr. 4. er festet. Husk å låse modulene på innsiden av grunnelementet.

5.

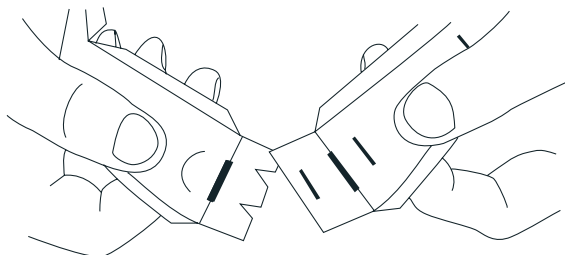

Ta ringelementet merket L og brett forsterkningskantene over. Monter ringelementet ved hjelp av "vingene".

6.

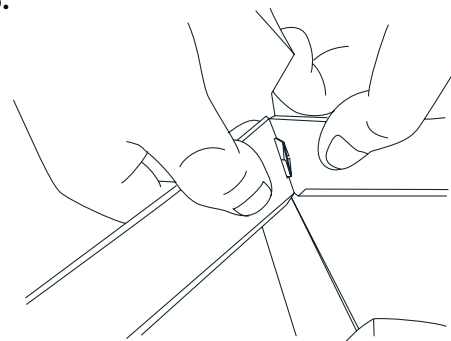

Sett ringelementet L på "vingene" på lampeskjermelementet, og lås dem ved å rette ut "vingene".

7.

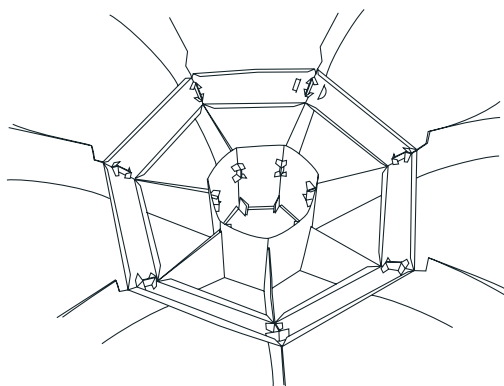

Riktig montert ringelement

8.

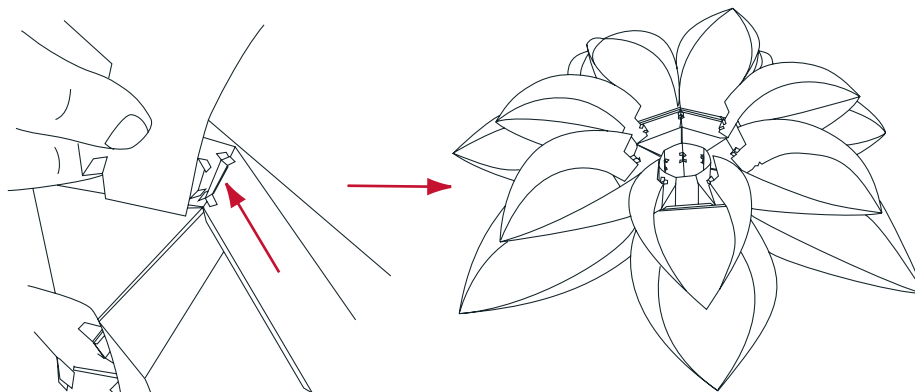

Brett de sju lampeskjermelementene merket 3. Brett forsiktig over langs buen på skjermelementet. Fest det første skjermelementet på ringelementet ved å skyve "vingene" gjennom hullet, der de andre "vingene" også er festet.

Fest resterende lampeskjermelementer på samme måte, hele veien rundt. Husk å låse modulene på baksiden.

9.

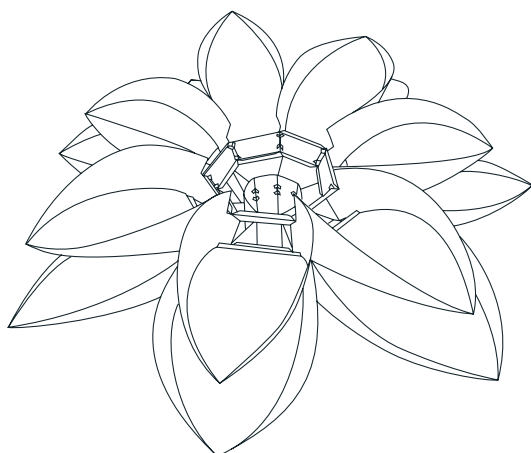

Monter og fest ringelement M på lampeskjermelementene merket 3.

10.

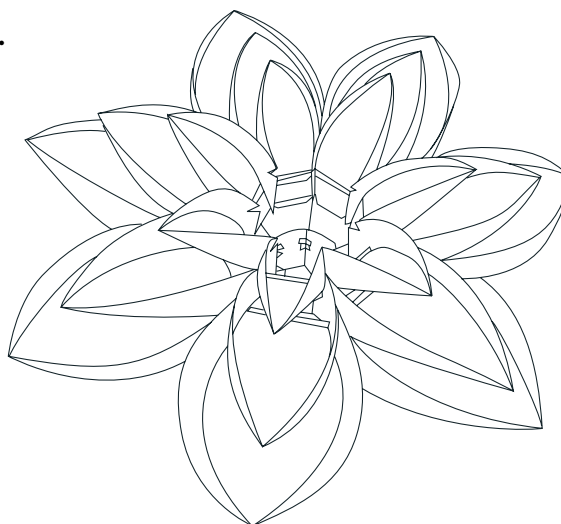

Brett lampeskjermelementene merket 2 og fest dem på ringelementet M hele veien rundt. Fest ringelement S.

11.

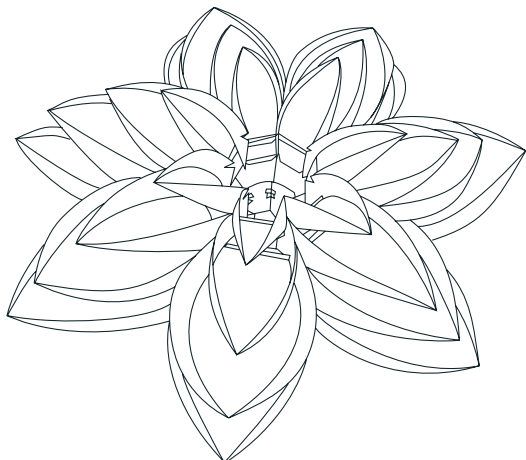

Brett de sju lampeskjermelementene merket I og fest dem på ringelementet S hele veien rundt.

12.

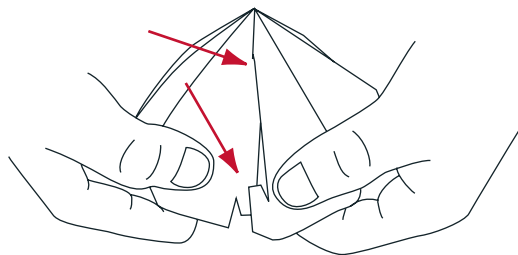

Bøy og monter grunnmodulen. Pass på at skjøtene vender innover.

13.

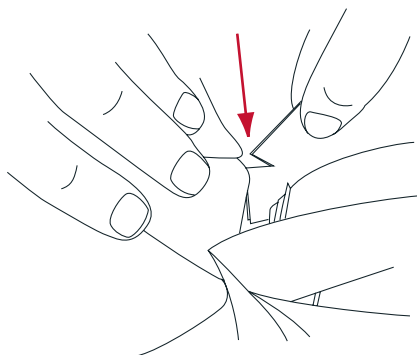

Fest grunnmodulen i slissene på de innerste lampeskjermelementene. (Slissene er små utsparinger.)

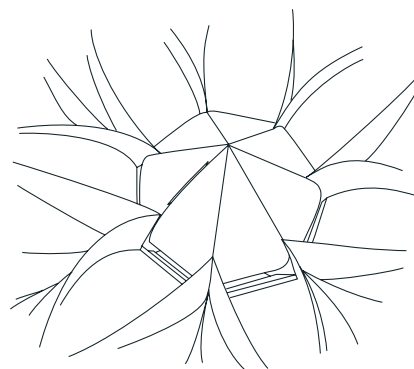

Den ferdigmonterte grunnmodulen.

14.

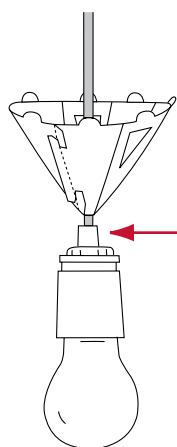

Klemmenippelen MÅ monteres.

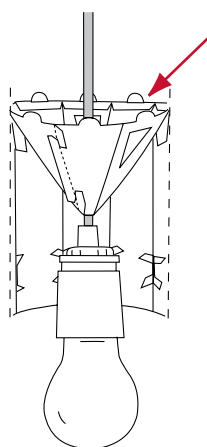

Bøy opphengingsmodulen i de seks retningene og monter den rundt ledningene slik at den former en kjele med sju sider.

Drei lampen slik at åpningen øverst i lampen vender opp. Før opphengingsmodulen ned i åpningen og skyv "vingene" gjennom hullene. Brett ned forsterkningskantene vannrett slik at de låser opphengingsmodulen.

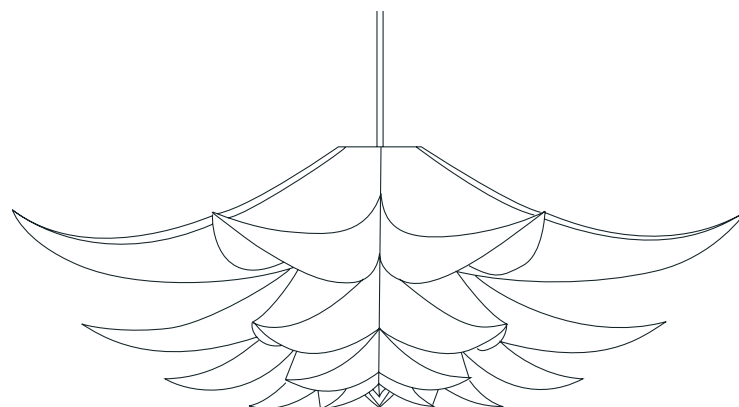

Den ferdigmonterte lampen klar til opphenging. Lampen kan henges opp uten at lyspærefestet fjernes. Det er enkelt å skifte pære takket være den fleksible lampesokkelen.

**MAKS. 60 WATT**



Contents:

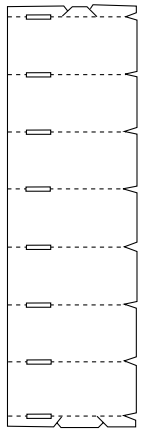

1 base element

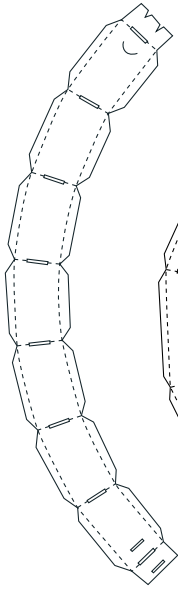

1 ring element S

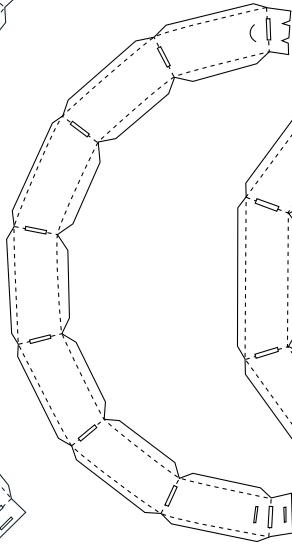

1 ring element M

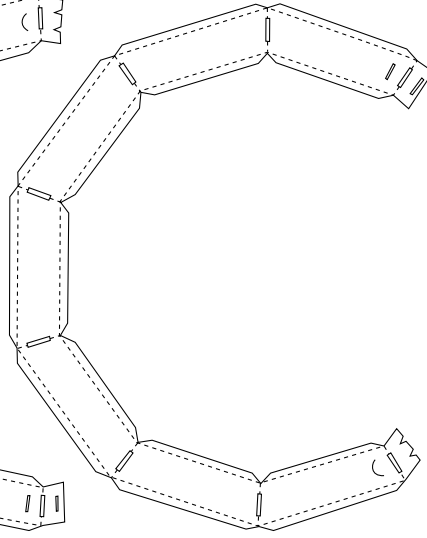

1 ring element L

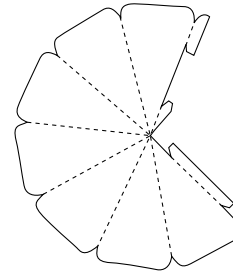

1 base module

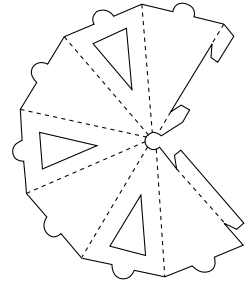

1 suspension module

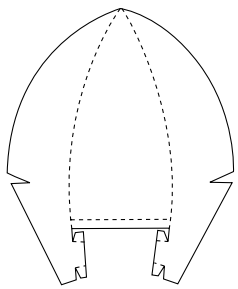

7 lampshade elements no. 1

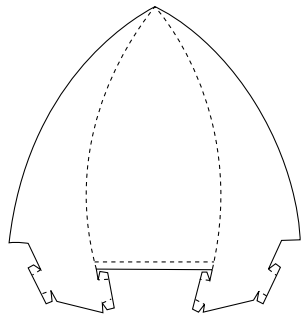

7 lampshade elements no. 2

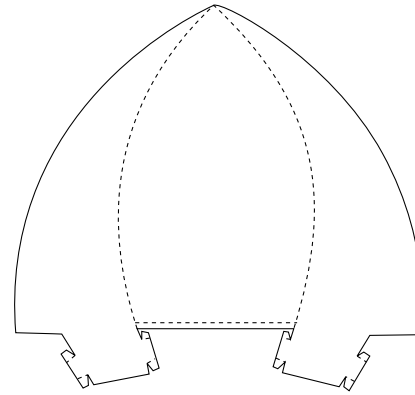

7 lampshade elements no. 3

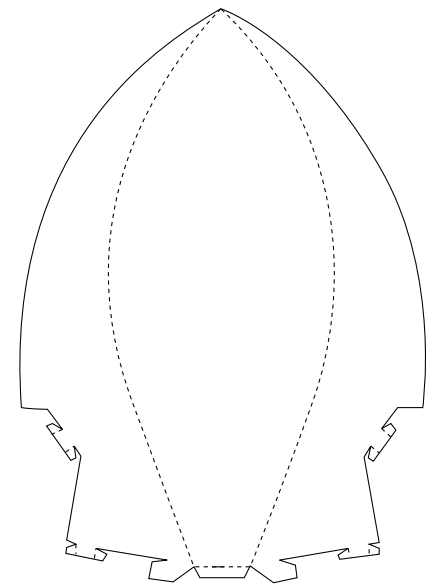

7 lampshade elements no. 4

Assembly instructions:

1.

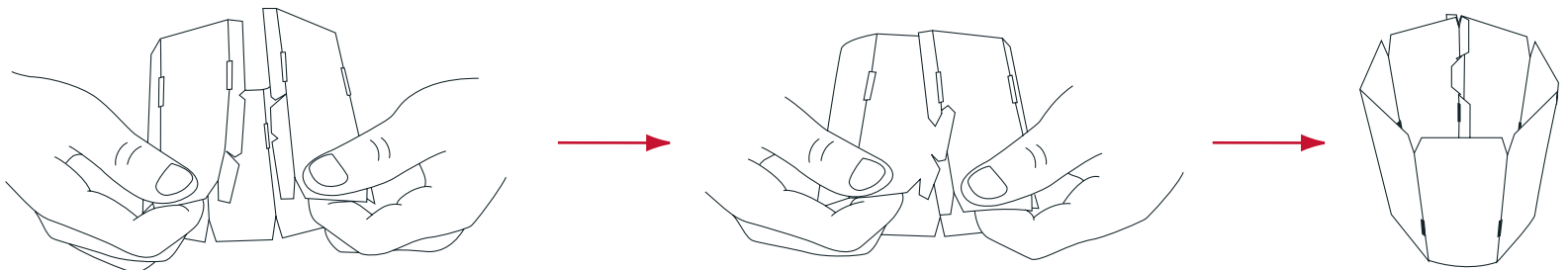

'Snap' the base together into a 7-sided cylinder with the matt side out.

**ASSEMBLY INSTRUCTIONS NORM 06 LARGE/ENGLISH**

2.

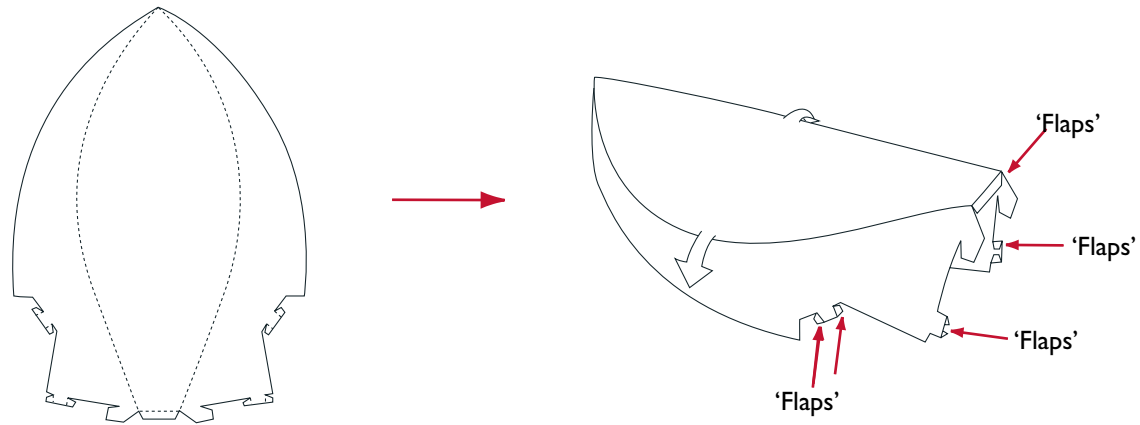

Fold the 7 lampshade elements marked '4' as shown. Fold carefully along the curve of the shade element.

Fold the 'flaps' in with the matt side out.

3.

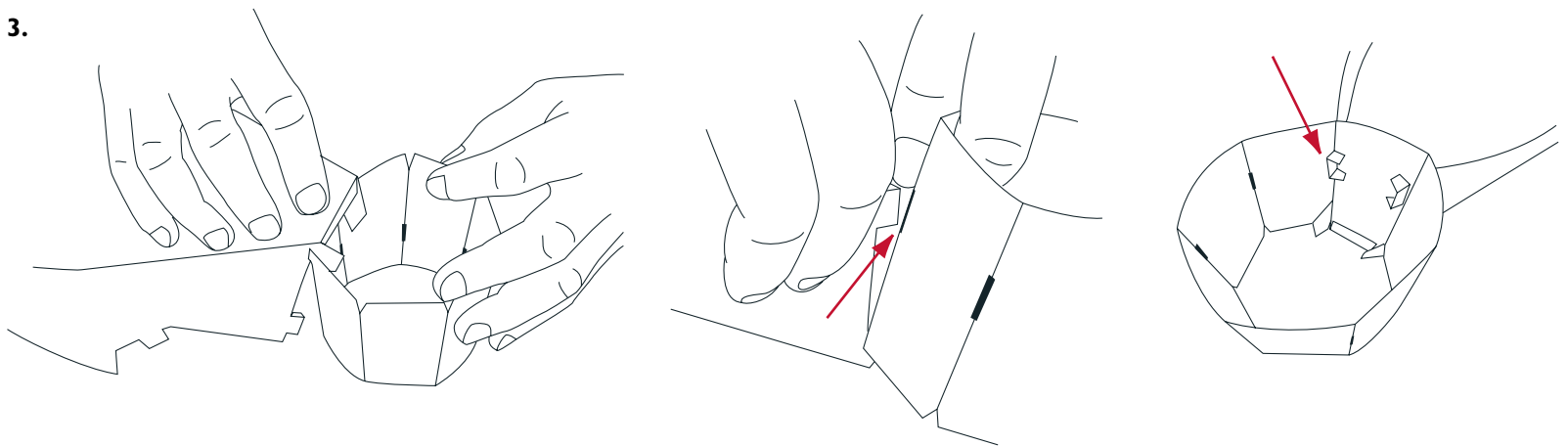

Hook the shade element onto the narrow part of the opening on the base element.

Turn the base element upside down and guide the 'flaps' through the holes, folding them over at the back to lock the module.

4.

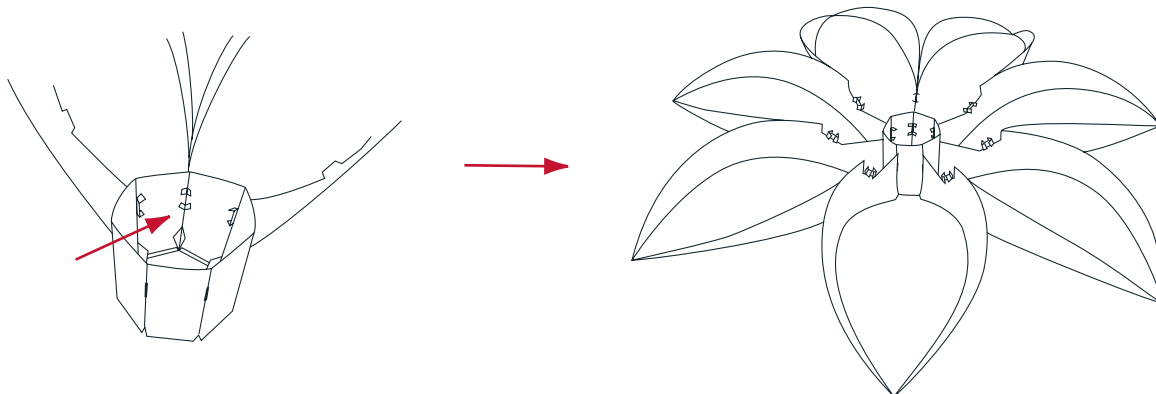

Place the next shade element on the base next to the first one and continue until all 7 lampshade elements no. 4 have been fitted. Remember to lock the modules on the inside of the base.

5.

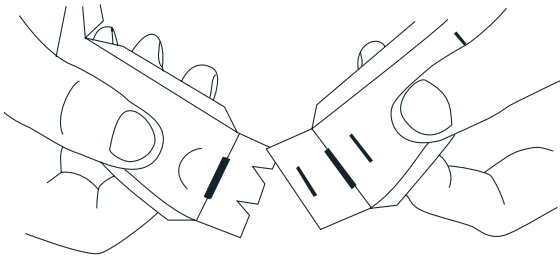

Take the ring element marked 'L' and fold the strengthening edges over. Assemble the ring element using the 'flaps'.

6.

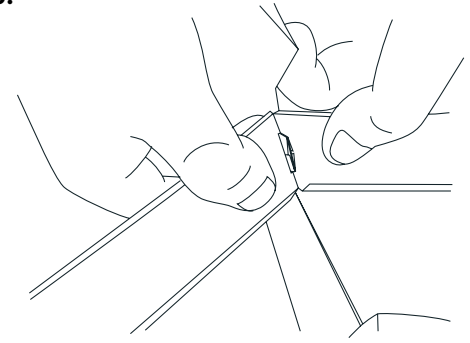

Mount ring element 'L' onto the 'flaps' on the lampshade element and lock them by straightening out the 'flaps'.

7.

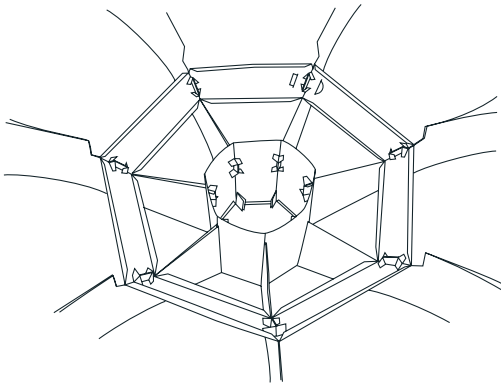

Correctly mounted ring element.

8.

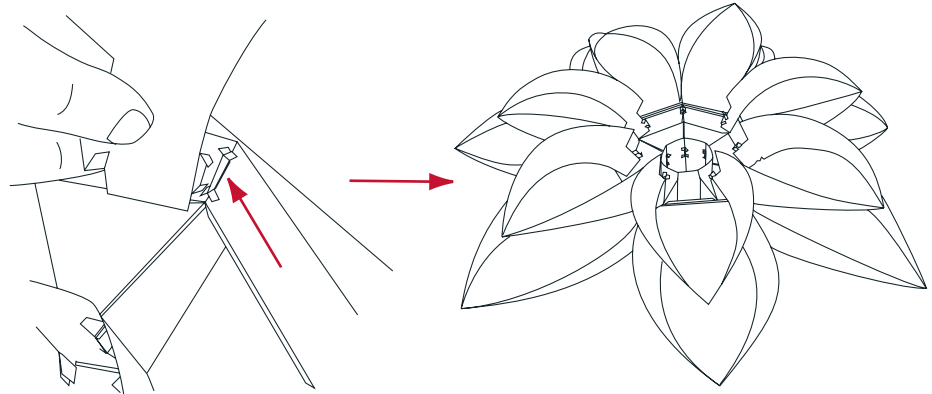

Fold the 7 lampshade elements marked '3'. Fold over carefully along the curve of the shade element. Mount the first shade element onto the ring element by pushing the 'flaps' through the hole where the other 'flaps' are also located.

Mount the rest of the lampshade elements similarly all the way round. Remember to lock the modules at the back.

9.

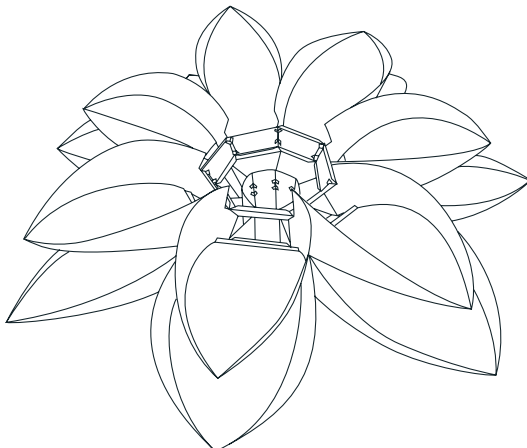

Assemble and mount ring element 'M' onto the lampshade elements marked '3'.

10.

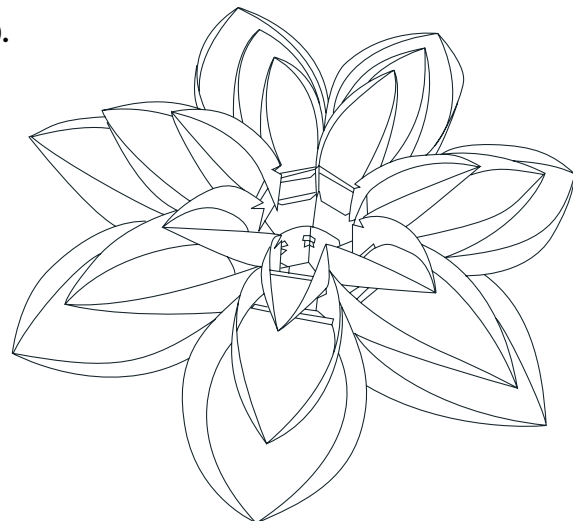

Fold the lampshade elements marked '2' and mount them onto ring element 'M' all the way round. Mount ring element 'S'.

11.

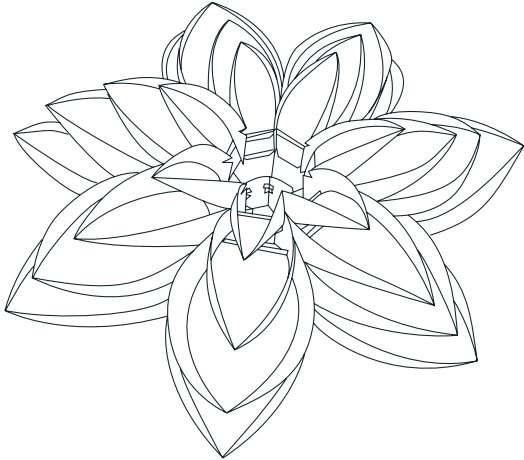

Fold the 7 lampshade elements marked 'I' and mount them onto ring element 'S' all the way round.

12.

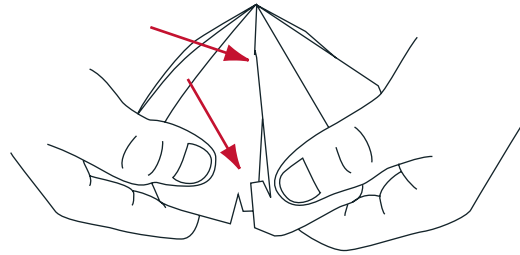

Bend and assemble the base module. Make sure joints turn inwards.

13.

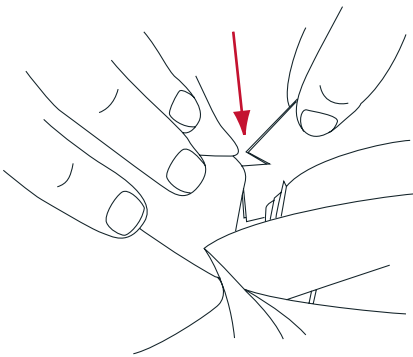

Fit the base module into the slots on the inner lampshade elements. (The slots are the small cut-outs).

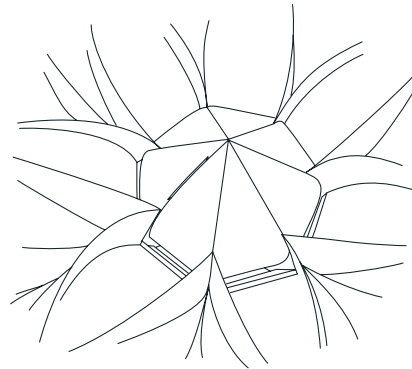

The fully assembled base module.

14.

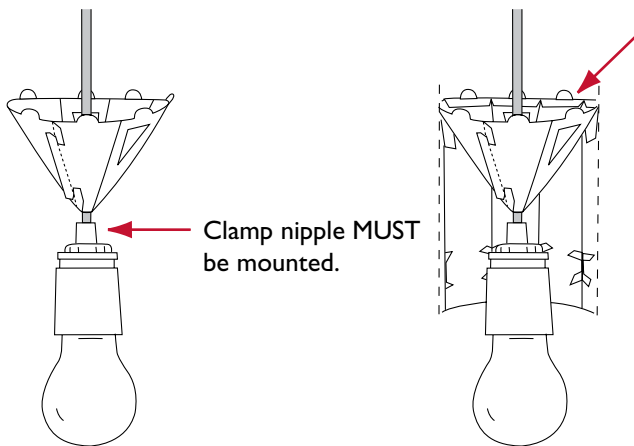

Bend the suspension module in the 6 directions and assemble around the wires so as to form a 7-sided cone.

Turn the lamp around so the opening at the top of the lamp is turned upwards. Lower the suspension module into the opening and push the 'flaps' through the holes. Turn down the strengthening edges horizontally so they lock the suspension module.

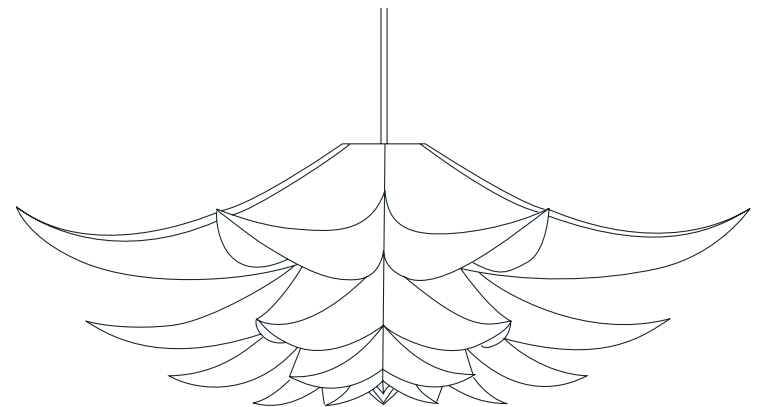

The fully assembled lamp ready for hanging. The lamp can be hung without removing the light fitting. Bulbs can be easily changed through the flexible base of the lamp.

**MAX 60 WATT**

**Inhalt:**

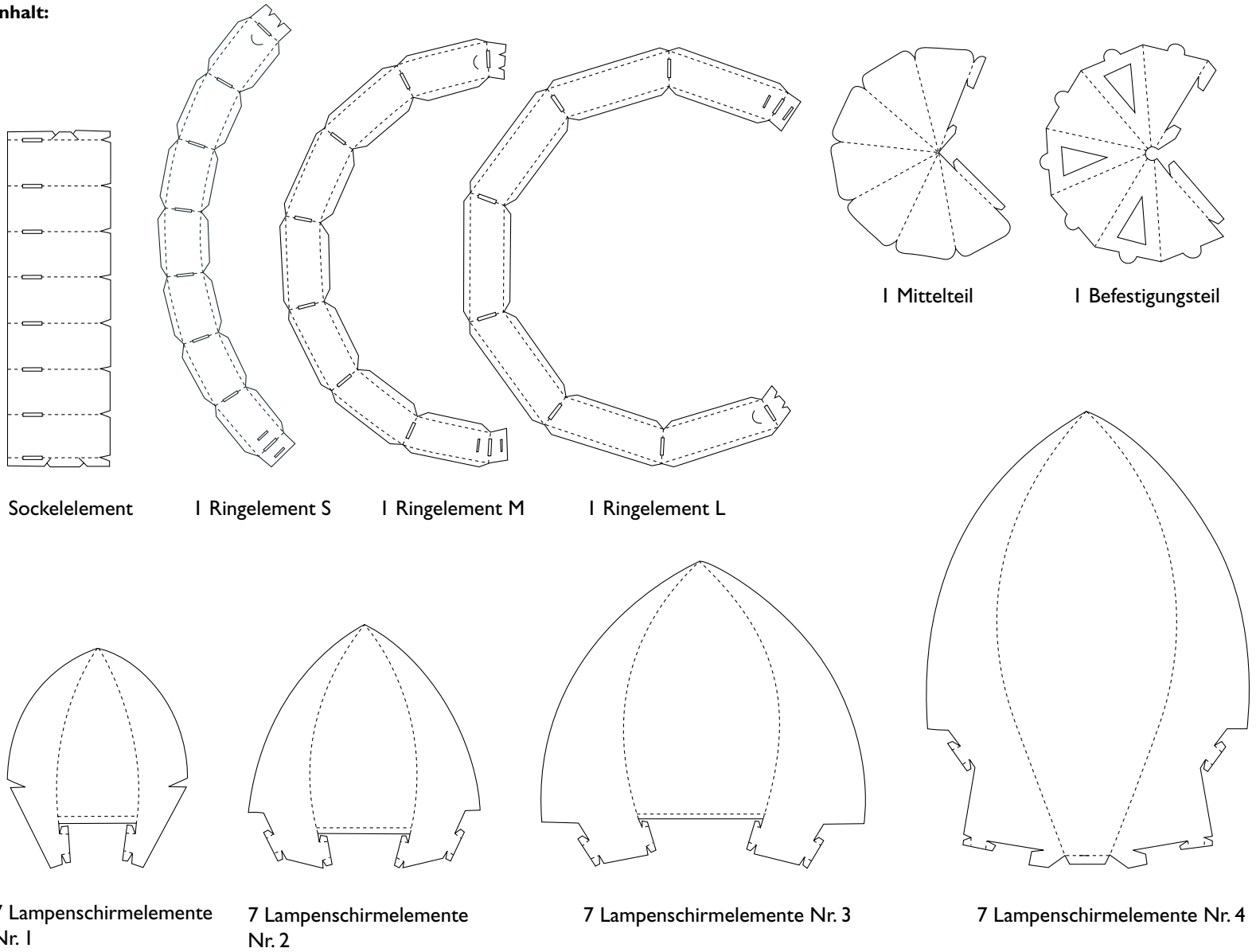

I Sockelelement

I Ringelement S

I Ringelement M

I Ringelement L

I Mittelteil

I Befestigungsteil

7 Lampenschirmelemente Nr. 1

7 Lampenschirmelemente Nr. 2

7 Lampenschirmelemente Nr. 3

7 Lampenschirmelemente Nr. 4

**Montageanleitung:**

I.

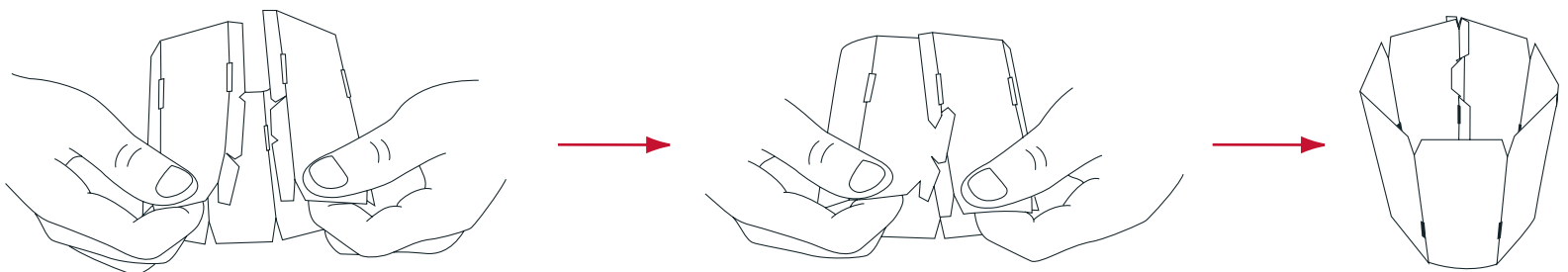

Knipsen Sie die Sockelelement so zusammen, dass ein 7-seitiger Zylinder entsteht, die matte Seite nach außen.

**2.**

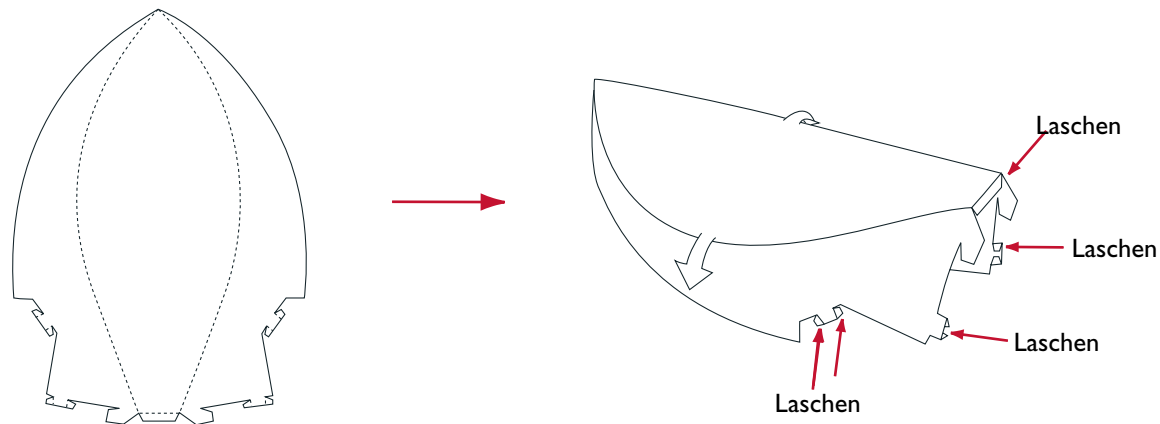

Falten Sie die 7 Lampenschirmelemente Nr. 4 wie angegeben. Falten Sie vorsichtig entlang der Rundung des Schirmelements.

Knicken Sie die Laschen nach innen, matte Seite nach außen.

**3.**

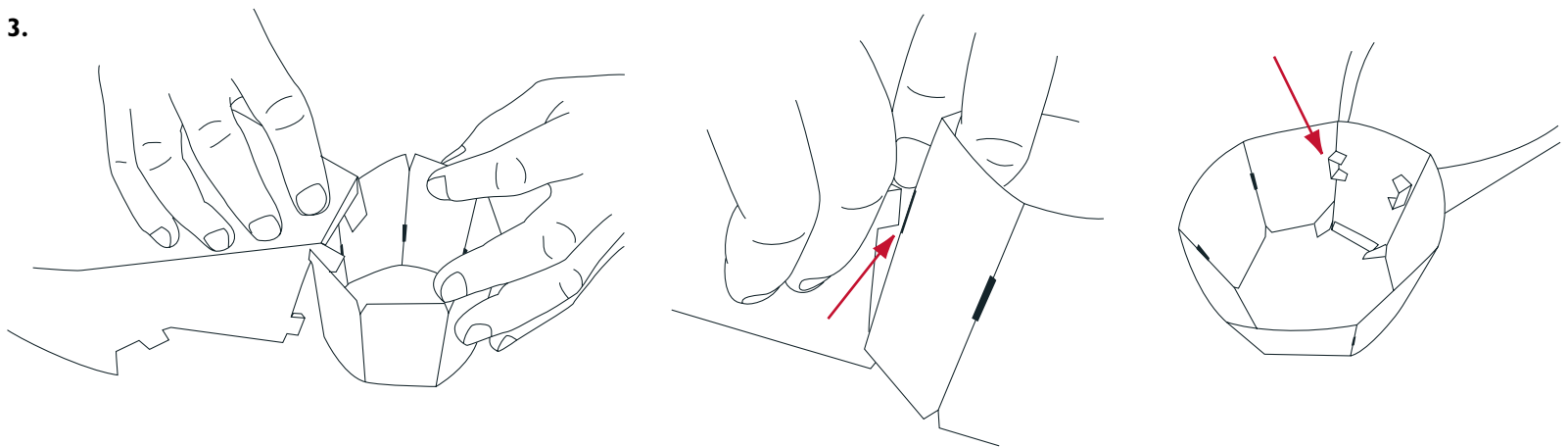

Haken Sie das Schirmelement an der engeren Öffnung des Sockelelements ein.

Wenden Sie das Ganze. Führen Sie die Laschen durch die Schlitzte und knicken Sie sie hinten um, um das Schirmelement zu fixieren.

**4.**

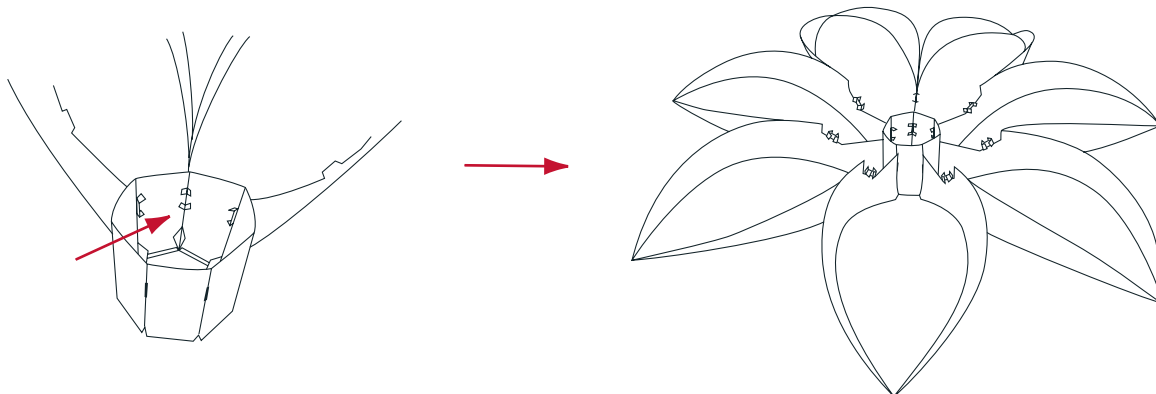

Befestigen Sie das nächste Schirmelement neben dem ersten, und tun Sie dasselbe mit den restlichen Lampenschirmelementen Nr. 4. Vergessen Sie nicht, die Elemente auf der Innenseite des Sockelelements zu fixieren.

5.

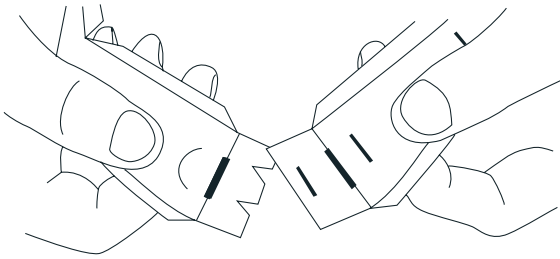

Nehmen Sie das Ringelement L und knicken Sie die Kanten zur Verstärkung nach innen. Setzen Sie den Ring mit Hilfe der Laschen zusammen.

6.

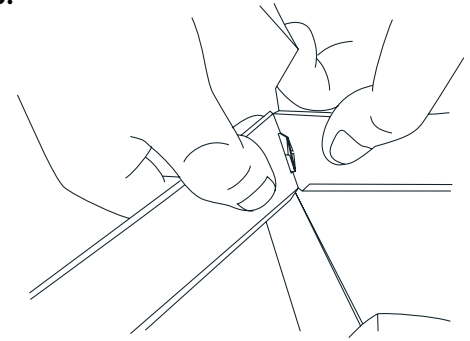

Setzen Sie das Ringelement L auf die dafür vorgesehenen Laschen auf den Lampenschirmelementen und fixieren Sie es, indem Sie die Laschen auseinanderfalten.

7.

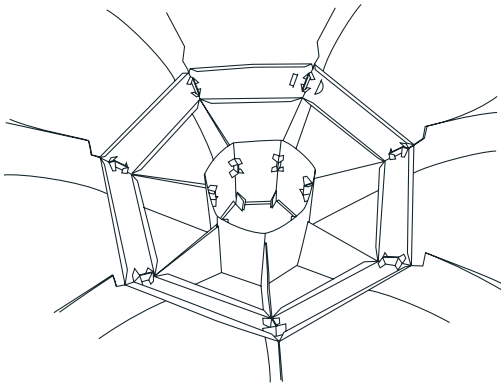

Korrekt aufgesetztes Ringelement.

8.

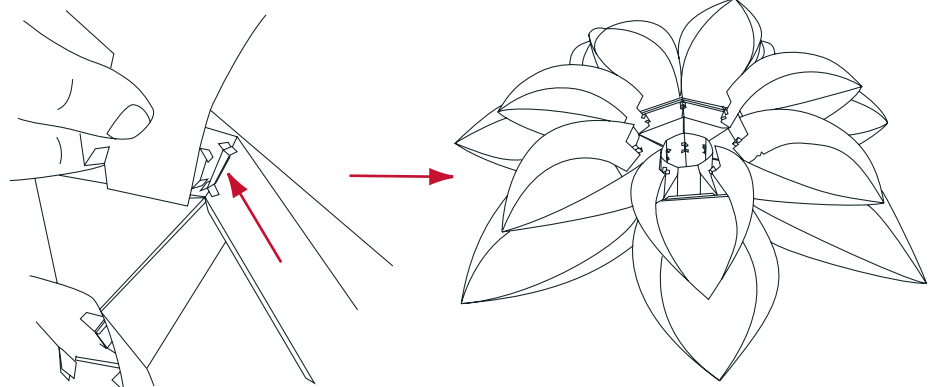

Falten Sie die 7 Lampenschirmelemente Nr. 3. Falten Sie vorsichtig entlang der Rundung des Schirmelements. Setzen Sie das erste Schirmelement Nr. 3 auf das Ringelement, indem Sie die Laschen durch den selben Schlitz führen, wie diejenigen des Schirmelements Nr. 4.

Tun Sie rundherum das selbe mit den restlichen Lampenschirmelementen Nr. 3. Vergessen Sie nicht, die Elemente hinten zu fixieren.

9.

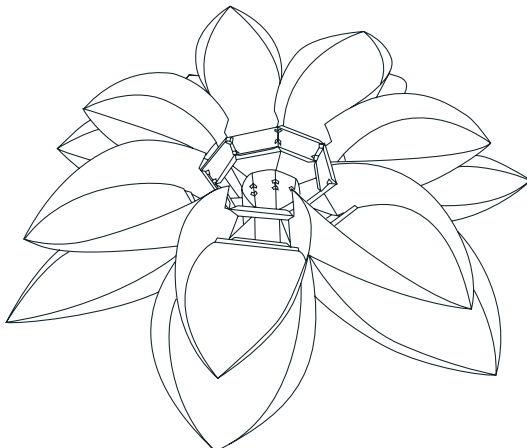

Setzen Sie das Ringelement M zusammen und befestigen Sie es auf den Lampenschirmelementen Nr. 3.

10.

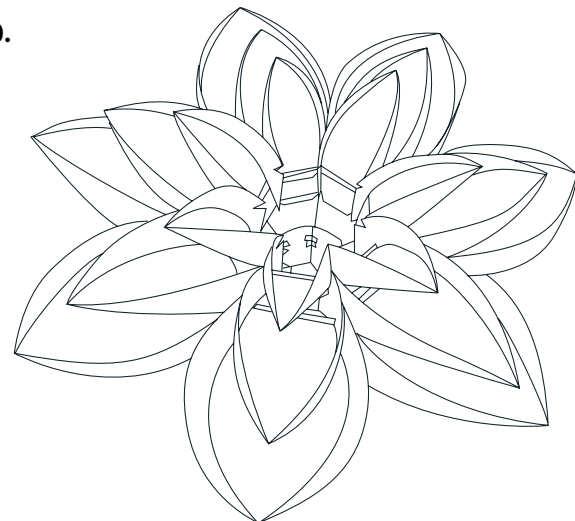

Falten Sie die Lampenschirmelemente Nr. 2 und setzen Sie sie rundherum auf das Ringelement M. Befestigen Sie das Ringelement S.

**11.**

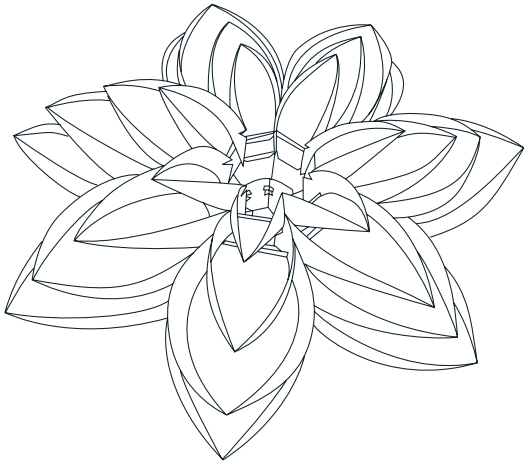

Falten Sie die Lampenschirmelemente Nr. 1 und setzen Sie sie rundherum auf das Ringelement S.

**12.**

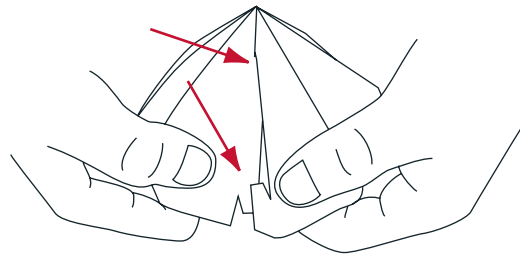

Formen Sie das Mittelteil und setzen Sie es zusammen. Achten Sie darauf, die Verbindungen nach innen zu wenden.

**13.**

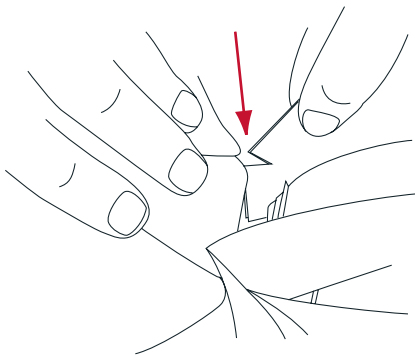

Befestigen Sie das Mittelteil in den Steckschlitz auf der Innenseite der Lampenschirmelemente (in den kleinen Einschnitten).

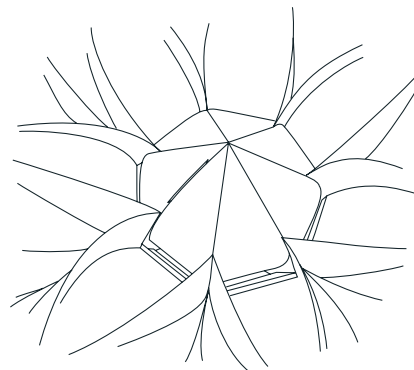

Das vollständig befestigte Mittelteil.

**14.**

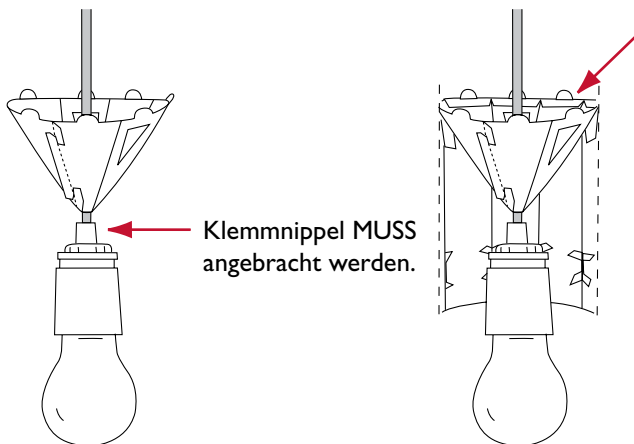

Formen Sie das Befestigungsteil und setzen Sie es so um das Kabel zusammen, dass ein 7-seitiger Kegel entsteht.

Wenden Sie die Lampe so, dass ihre obere Öffnung nach oben zu liegen kommt. Senken Sie das Befestigungsteil in die Öffnung und führen Sie die Laschen durch die Schlitzte. Knicken Sie die Kanten zur Stärkung horizontal, damit sie das Befestigungsteil fixieren.

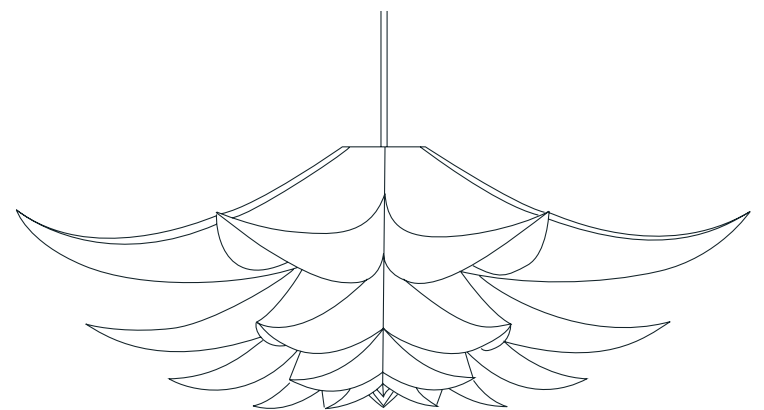

Die vollständig montierte Leuchte bereit zum Aufhängen. Die Leuchte kann aufgehängt werden, ohne dass der Beleuchtungskörper entfernt werden muss. Dank des flexiblen Sockelelements können Glühlampen einfach ausgetauscht werden.

**MAX. 60 WATT**



Contenu :

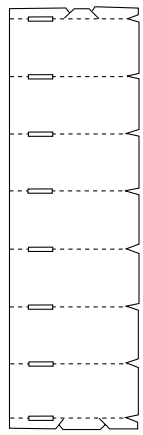

1 socle

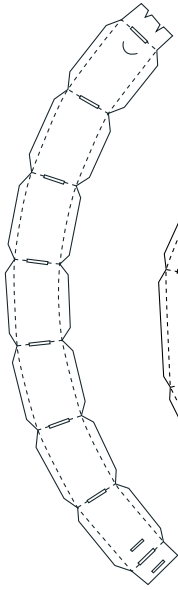

1 anneau S

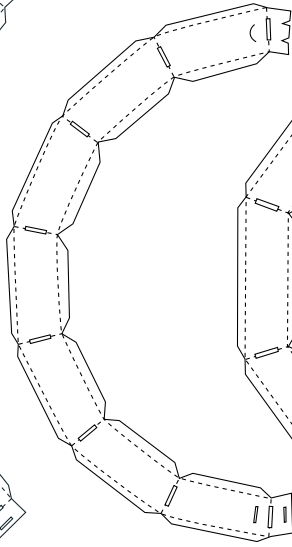

1 anneau M

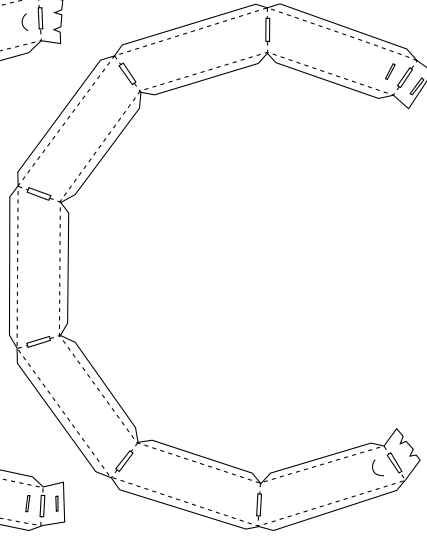

1 anneau L

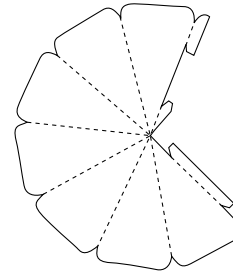

1 module de base

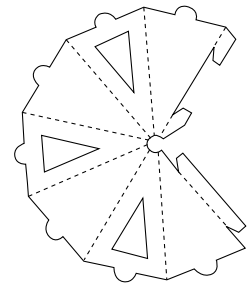

1 module de suspension

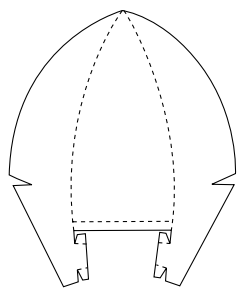

7 abat-jour n°1

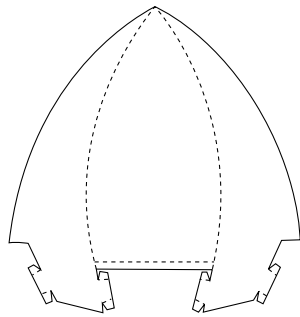

7 abat-jour n°2

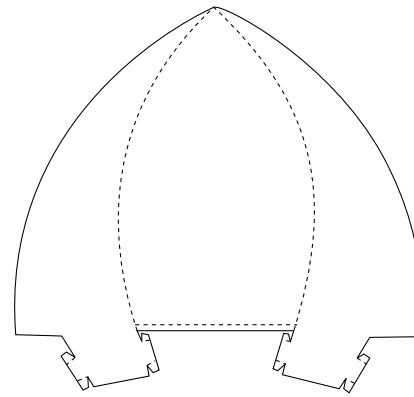

7 abat-jour n°3

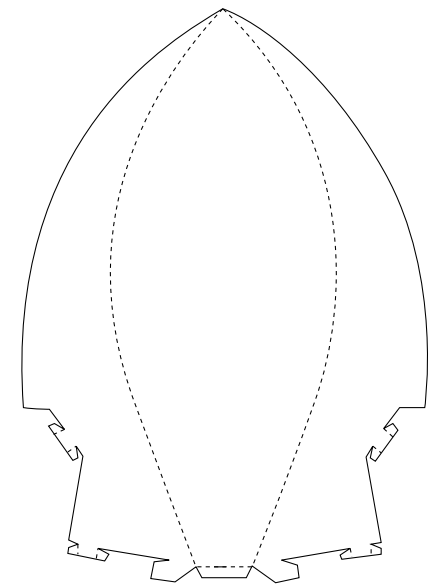

7 abat-jour n°4

Instructions d'assemblage :

I.

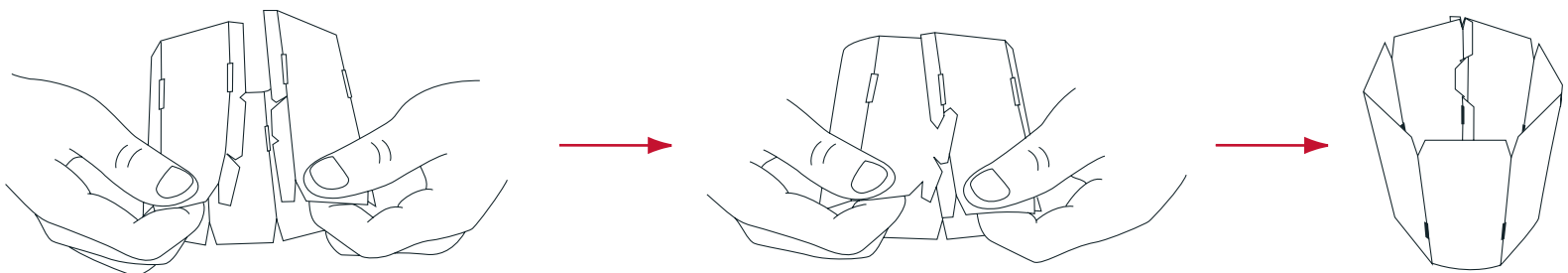

Enclenchez la base dans le cylindre heptagonal avec le côté mat vers l'extérieur.

## INSTRUCTIONS D'ASSEMBLAGE NORM 06 LARGE/FRANCAIS

2.

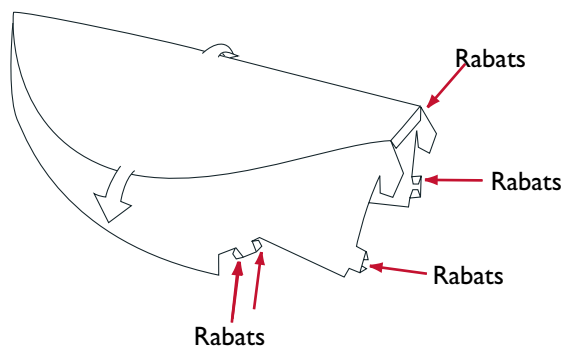
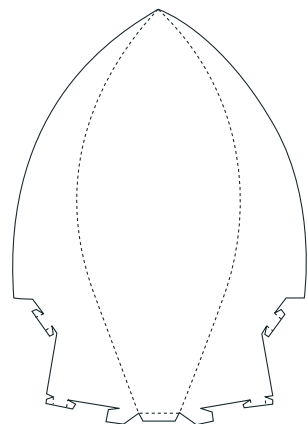

Pliez les 7 abats-jour comportant le chiffre '4', tel que cela est indiqué. Pliez soigneusement le long de la courbe de l'abat-jour.

Pliez les rabats avec le côté mat vers l'extérieur.

3.

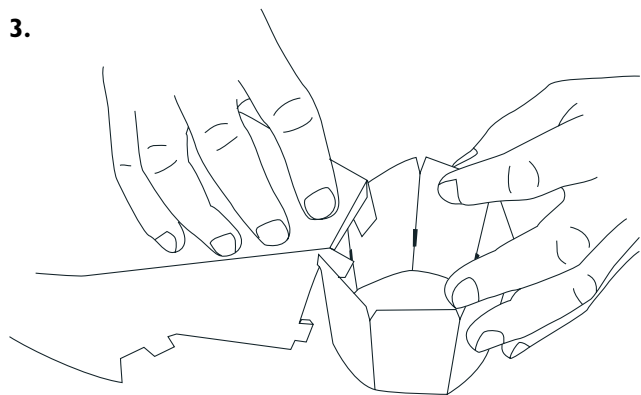

Accrochez l'abat-jour sur la partie étroite de l'ouverture du socle.

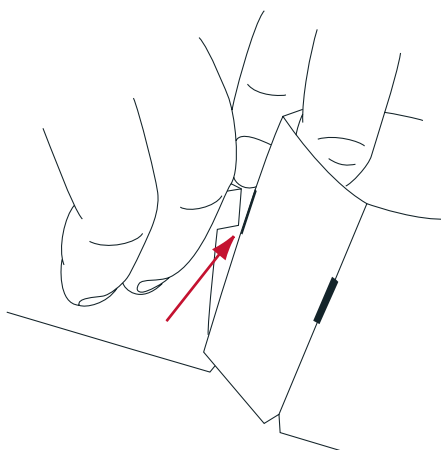

Tournez le socle dans l'autre sens et insérez les rabats dans les trous, en les pliant à l'arrière pour verrouiller le module.

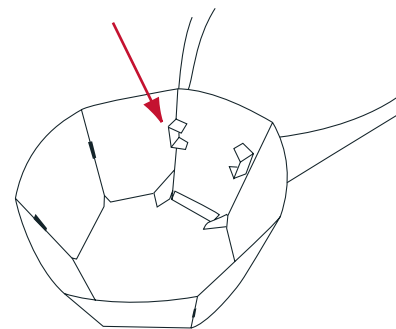

4.

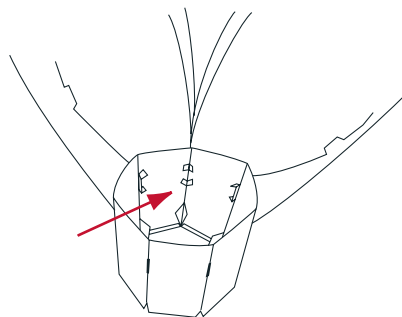

Placez l'abat-jour suivant sur le socle suivant et continuez jusqu'à fixation des 7 abats-jour comportant le chiffre 4. Veillez à verrouiller les modules à l'intérieur de la base.

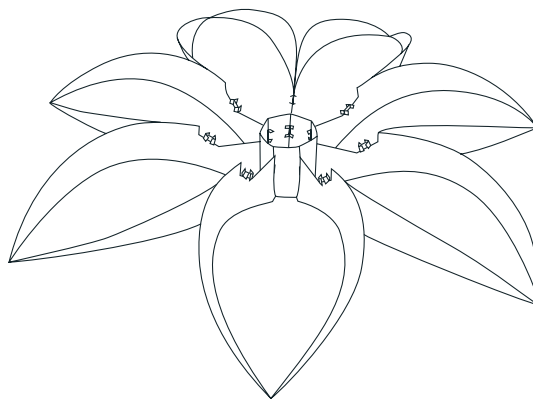

5.

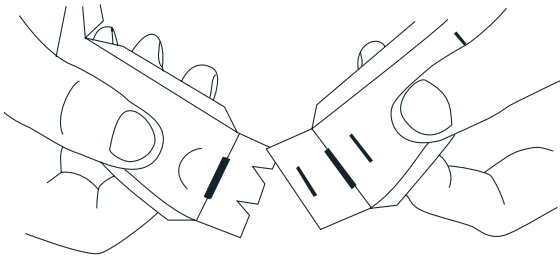

Prenez l'anneau comportant la lettre 'L' et repliez les bords renforcés. Assemblez l'anneau à l'aide des rabats.

6.

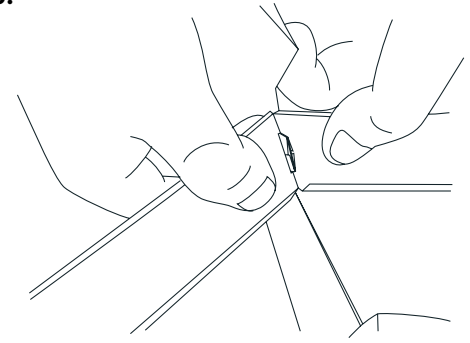

Montez l'anneau 'L' sur les rabats de l'abat-jour et verrouillez-les en redressant les rabats.

7.

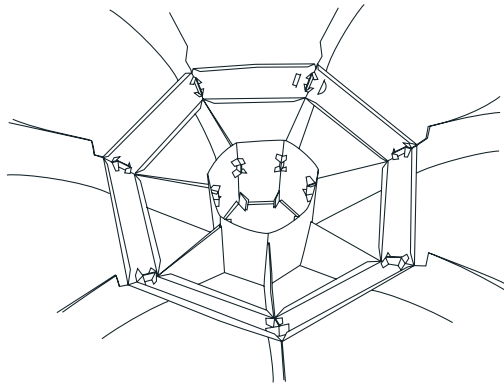

Anneau correctement monté.

8.

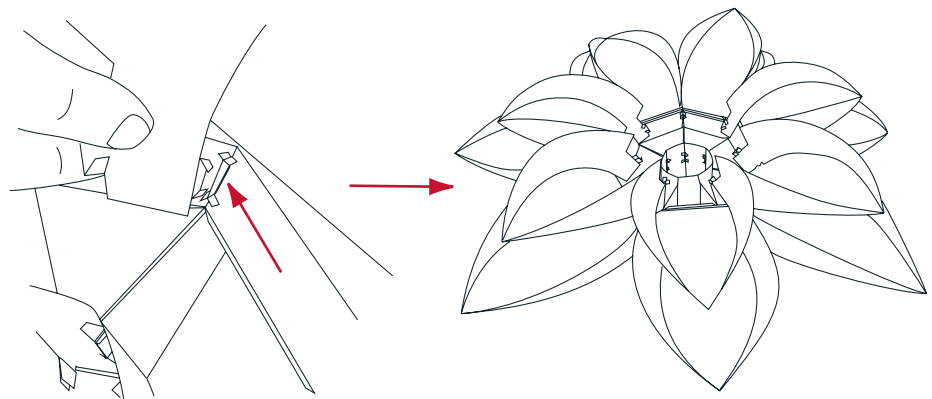

Pliez les 7 abats-jour comportant le chiffre '3'. Pliez soigneusement le long de la courbe de l'abat-jour. Montez le premier abat-jour sur l'anneau en insérant les rabats dans le trou où se trouvent les autres rabats.

Montez le reste des abats-jour en procédant de la même manière. Veillez à verrouiller les modules à l'arrière.

9.

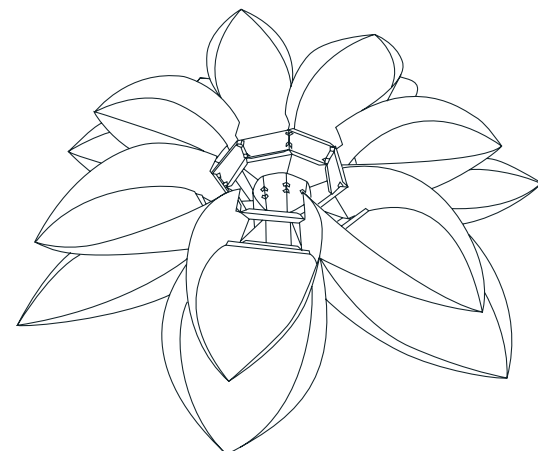

Assemblez et montez l'anneau 'M' sur les abats-jour comportant le chiffre '3'.

10.

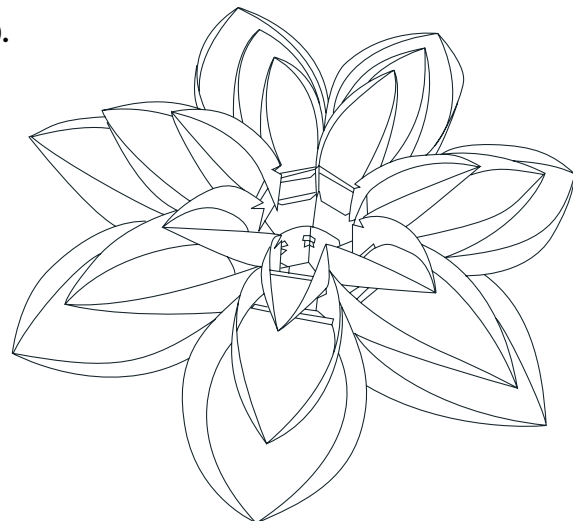

Pliez les abats-jour comportant le chiffre '2' et montez-les sur l'anneau 'M' de la même manière. Montez l'anneau 'S'.

## INSTRUCTIONS D'ASSEMBLAGE NORM 06 LARGE/FRANCAIS

11.

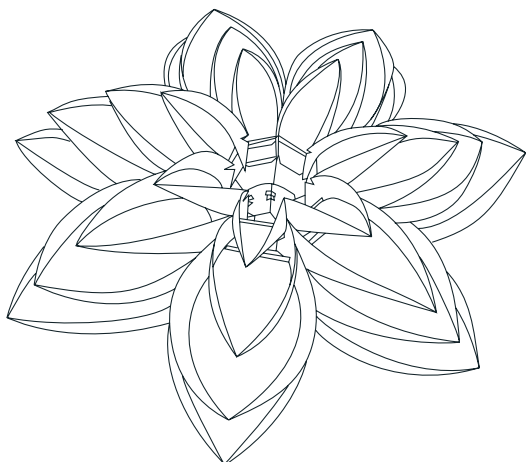

Pliez les 7 abat-jour comportant le chiffre '1' et montez-les sur l'anneau 'S' de la même manière.

12.

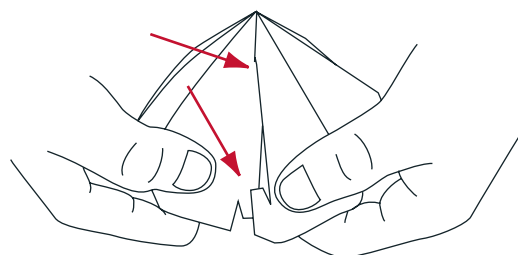

Pliez et assemblez le module de base. Assurez-vous que les joints sont tournés vers l'intérieur.

13.

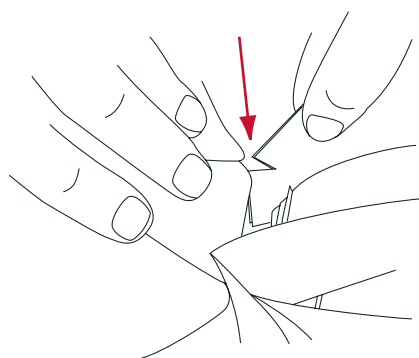

Fixez le module de base dans les fentes des abat-jour internes. (Les fentes sont de petites entailles).

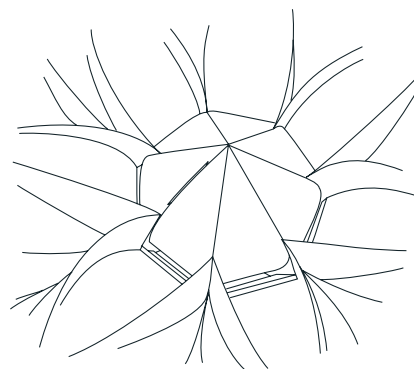

Le module de base assemblé.

14.

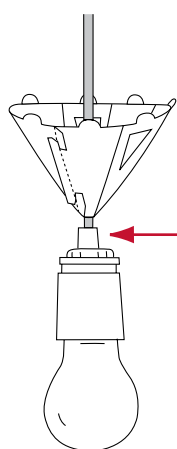

La douille DOIT être montée.

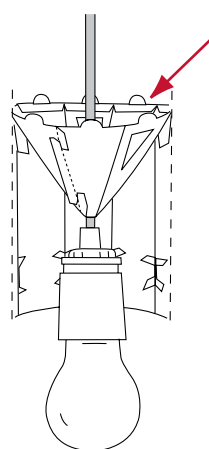

Pliez le module de suspension dans les 6 directions et assemblez autour du fil de façon à former un cône heptagonal.

Tournez la lampe de façon à ce que l'ouverture au sommet de la lampe soit tournée vers le haut. Baissez le module de suspension dans l'ouverture et passez les rabats dans les trous. Rabaissez les bords renforcés horizontalement de façon à ce qu'ils soient fixés au module de suspension.

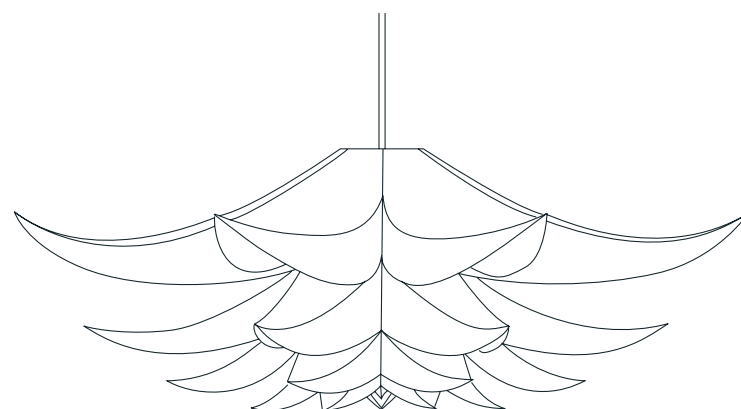

La lampe assemblée peut maintenant être accrochée. La lampe peut être accrochée sans retirer l'ampoule. Les ampoules peuvent être facilement remplacées grâce à la base flexible de la lampe.

**MAX 60 WATTS**

Contenido:

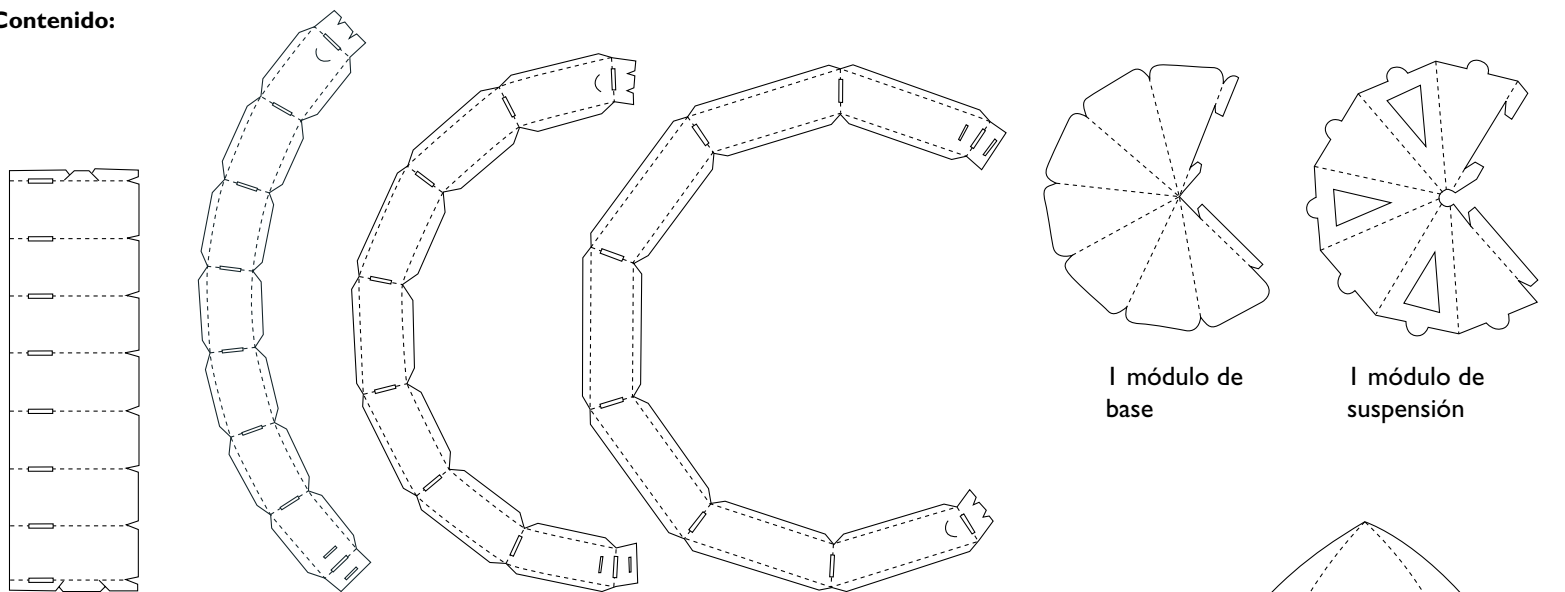

1 elemento de base

1 elemento circular pequeño S

1 elemento circular mediano M

1 elemento circular grande L

1 módulo de base

1 módulo de suspensión

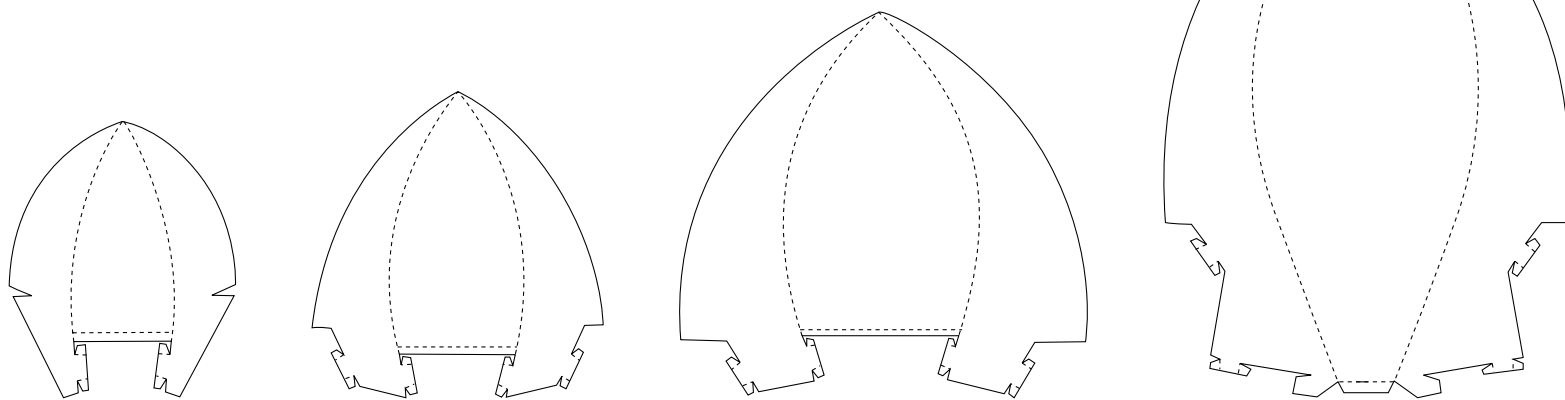

7 elementos de pantalla n.º 1

7 elementos de pantalla n.º 2

7 elementos de pantalla n.º 3

7 elementos de pantalla n.º 4

Instrucciones de montaje:

1.

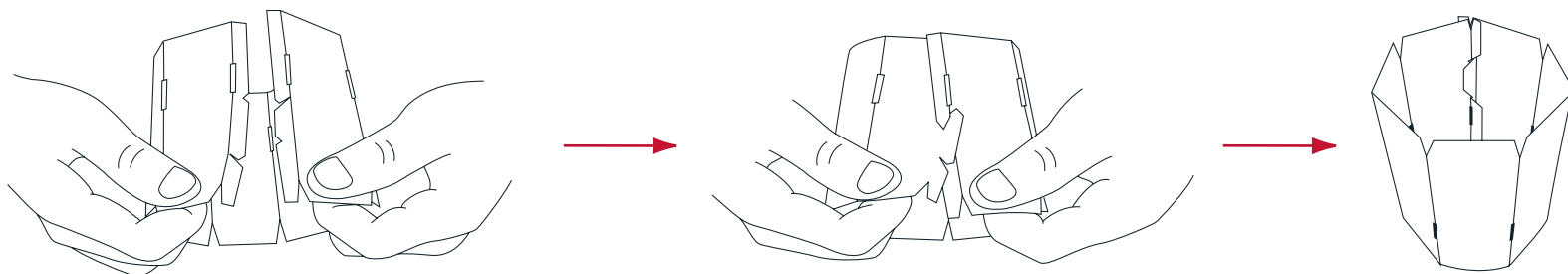

Cierre la base con el lado mate hacia afuera formando un cilindro de siete lados.

## INSTRUCCIONES DE MONTAJE DE NORM 06 LARGE/ESPAÑOL

2.

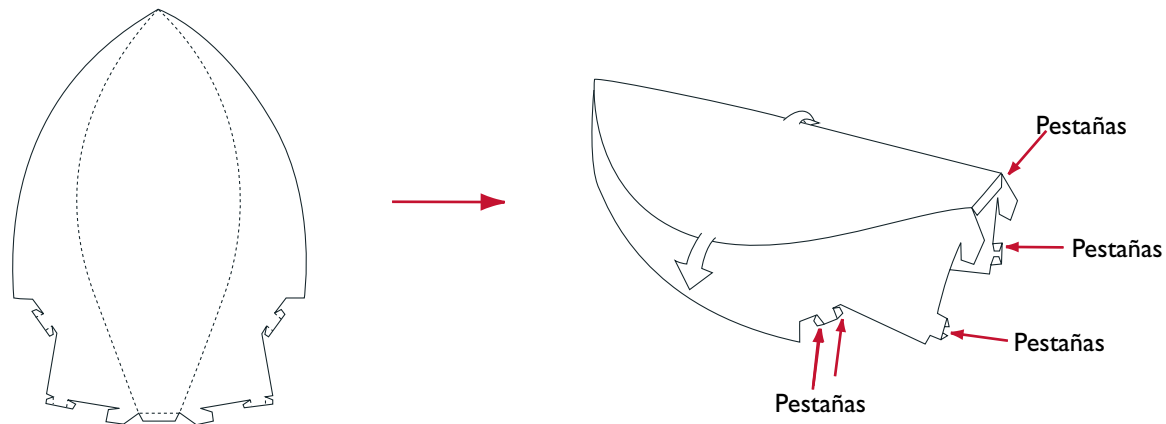

Pliegue los siete elementos de pantalla marcados con el número 4, como se muestra en la figura. Realice la operación con cuidado de seguir la curva del elemento de pantalla.

Doble las pestañas o lengüetas hacia adentro con el lado mate hacia afuera.

3.

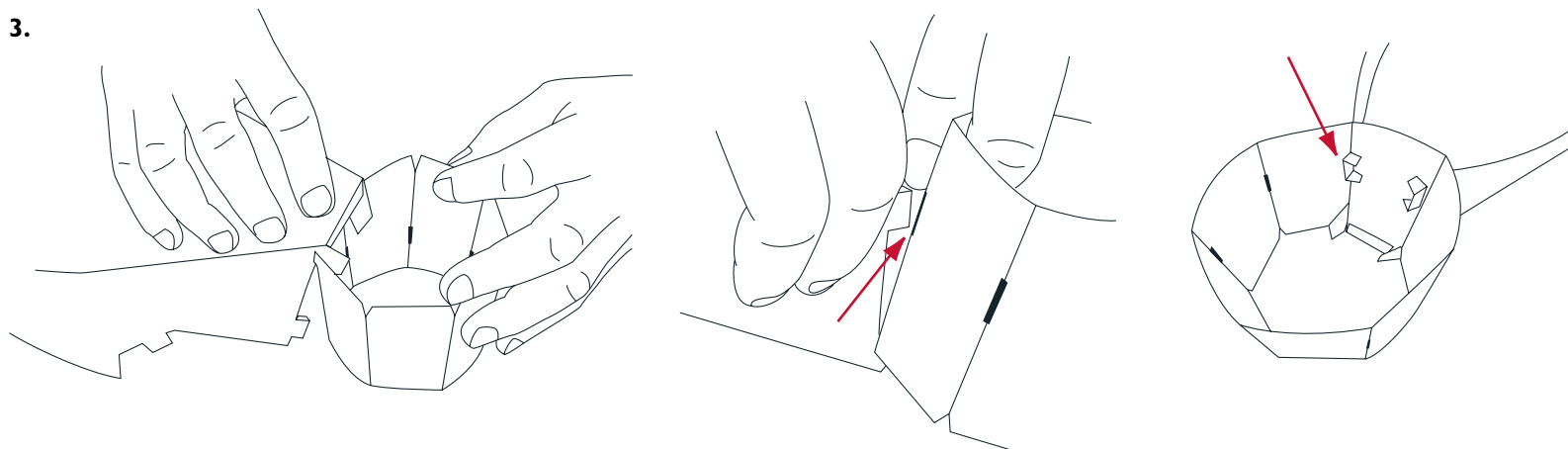

Enganche el elemento de pantalla a la parte estrecha de la abertura del elemento de base.

Ponga el elemento de base boca abajo, haga pasar las pestañas por los agujeros y dóblelas sobre la parte posterior para sujetar el módulo.

4.

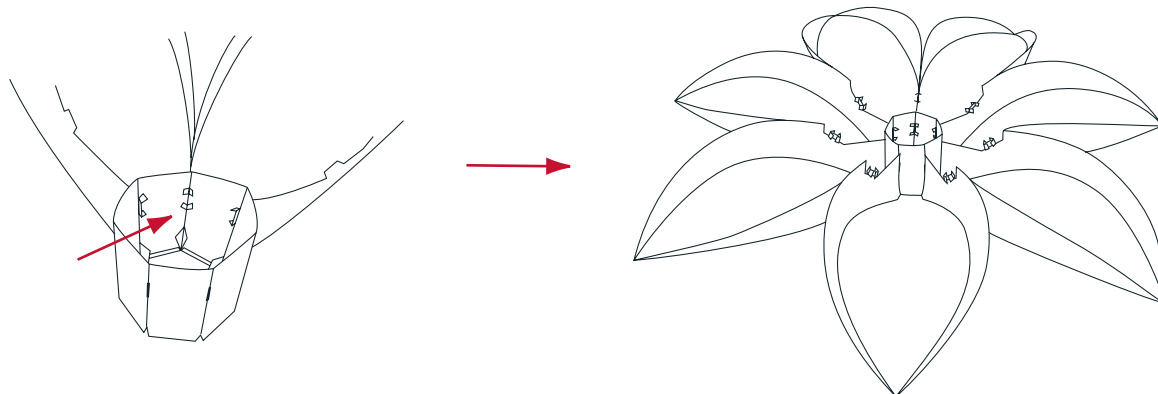

Coloque el siguiente elemento de la pantalla sobre la base, junto al primero, y continúe hasta haber ajustado los siete elementos marcados con el número 4. No olvide sujetar los módulos por el lado interior de la base.

5.

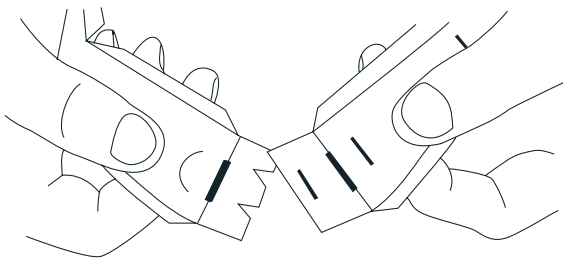

Sujete el elemento circular marcado como L y doble sobre sí mismos los bordes de refuerzo. Monte el elemento circular usando las pestañas.

6.

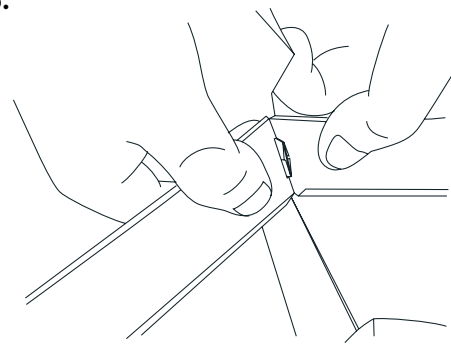

Monte el elemento circular L sobre las pestañas del elemento de pantalla y sujételos enderezando las pestañas.

7.

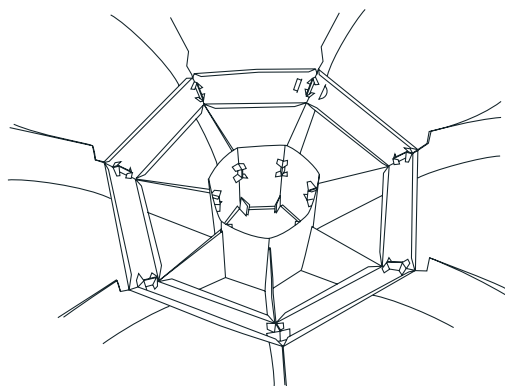

El elemento circular montado correctamente.

8.

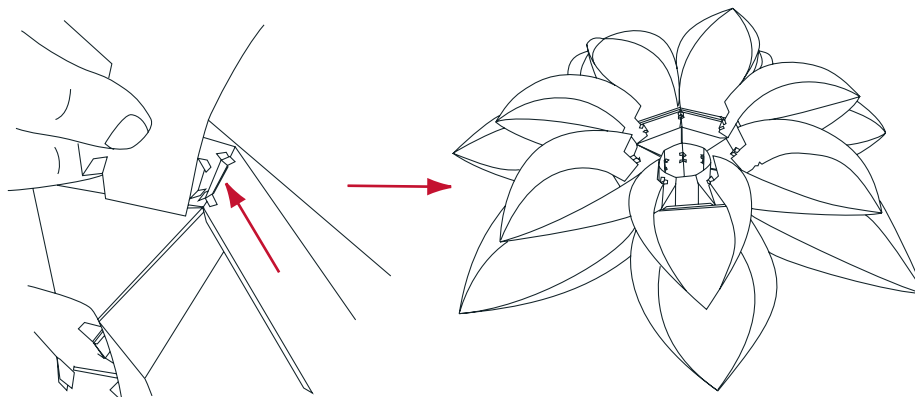

Pliegue los siete elementos de pantalla marcados con el número 3. Realice la operación con cuidado de seguir la curva del elemento de pantalla. Monte el primer elemento de la pantalla sobre el elemento circular haciendo pasar las pestañas por el agujero en el que también están las otras pestañas.

Monte el resto de los elementos de la pantalla a su alrededor. No olvide sujetar los módulos en la parte posterior.

9.

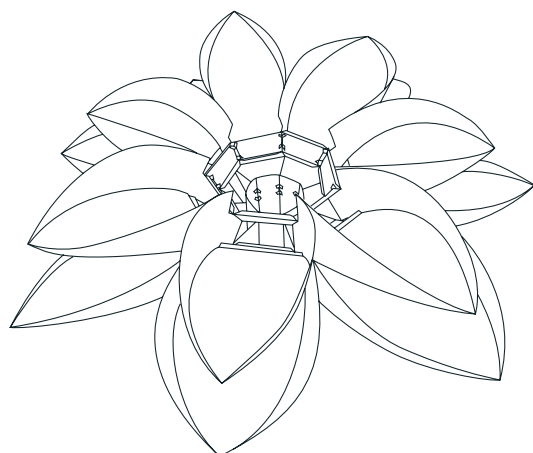

Arme y monte el elemento circular M sobre los elementos de la pantalla marcados con el número 3.

10.

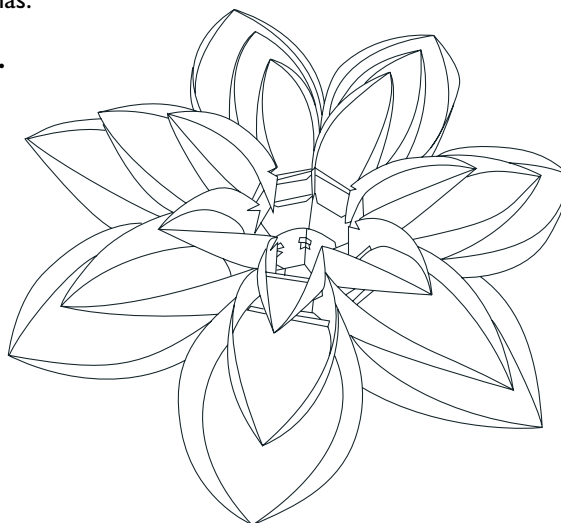

Pliegue los elementos de la pantalla marcados con el número 2 y móntelos sobre la circunferencia del elemento circular M. Monte el elemento circular S.

11.

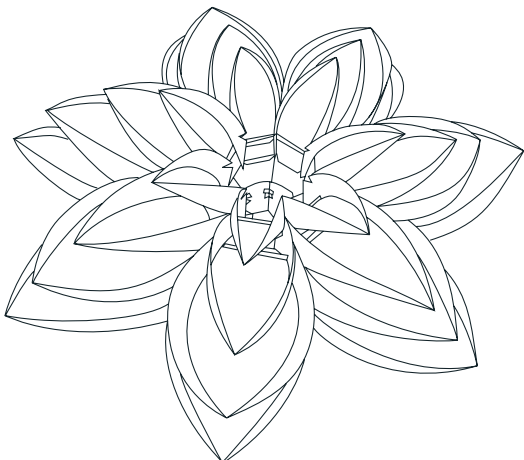

Pliegue los siete elementos de la pantalla marcados con el número 1 y móntelos sobre la circunferencia del elemento circular S.

12.

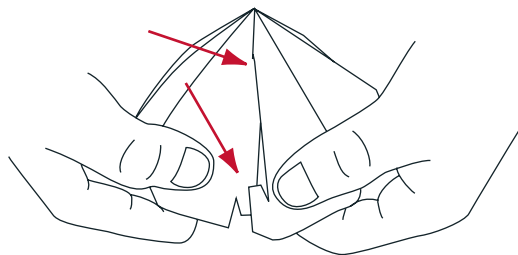

Doble y monte el módulo de base. Las uniones deben girarse hacia adentro.

13.

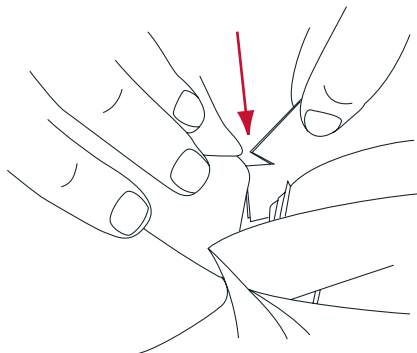

Coloque el módulo de base en las ranuras (cortes pequeños) de los elementos interiores de la pantalla.

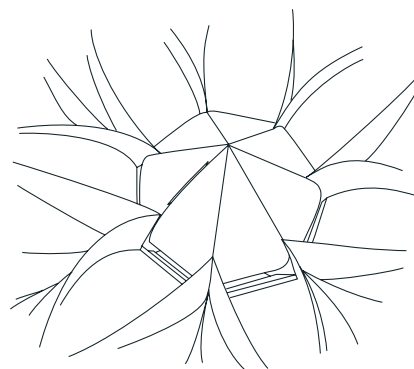

El módulo de base totalmente montado.

14.

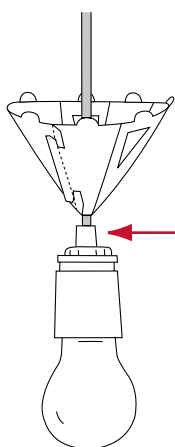

El manguito prisionero DEBE estar montado.

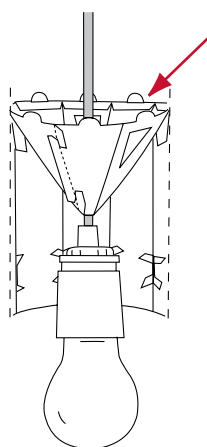

Pliegue el módulo de suspensión en las seis direcciones y móntelo alrededor de los alambres para formar un cono de siete lados.

Dé la vuelta a la lámpara para que la abertura de la parte superior mire hacia arriba. Baje el módulo de suspensión por la abertura y empuje las pestañas por los agujeros. Vuelva los bordes de refuerzo en horizontal para que sujeten el módulo de suspensión.

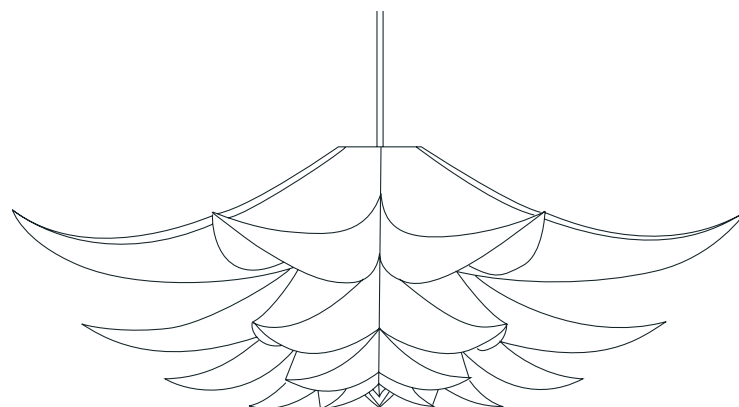

La lámpara terminada de montar, lista para colgarla. La lámpara puede colgarse sin necesidad de quitar el portalámparas. Las bombillas pueden cambiarse con facilidad a través de la base flexible de la lámpara.

**MÁX 60 VATIOS**



**Componenti:**

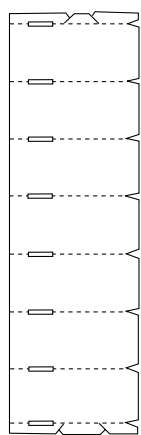

1 elemento base

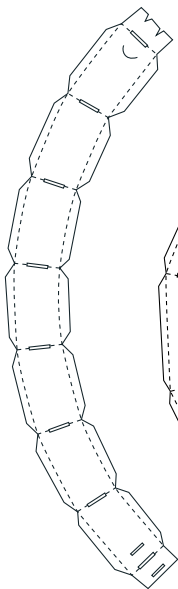

1 elemento ad anello S

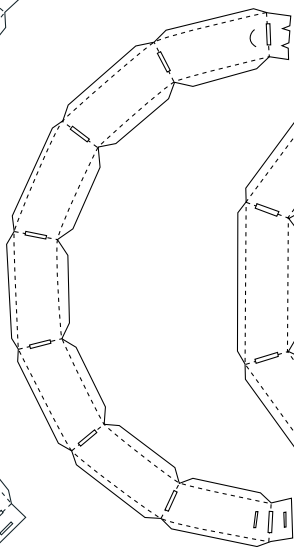

1 elemento ad anello M

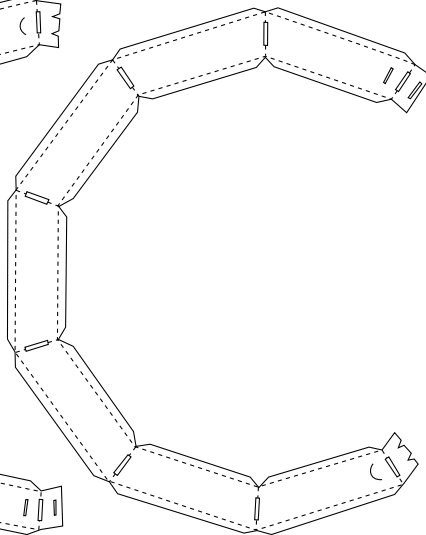

1 elemento ad anello L

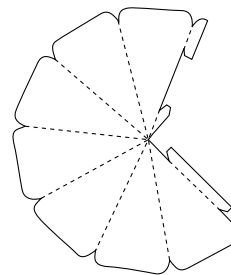

1 modulo base

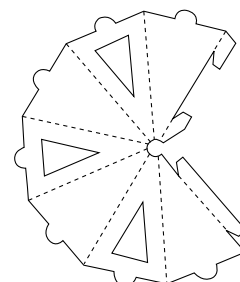

1 modulo di sospensione

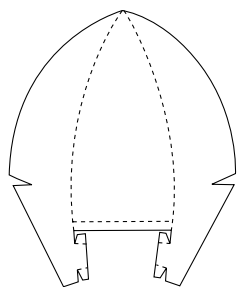

7 elementi paralume n. 1

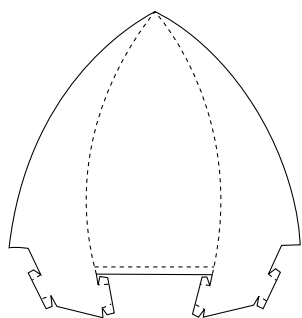

7 elementi paralume n. 2

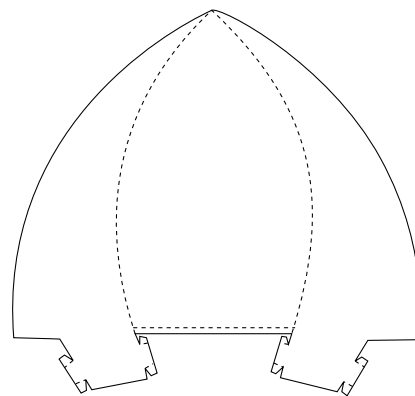

7 elementi paralume n. 3

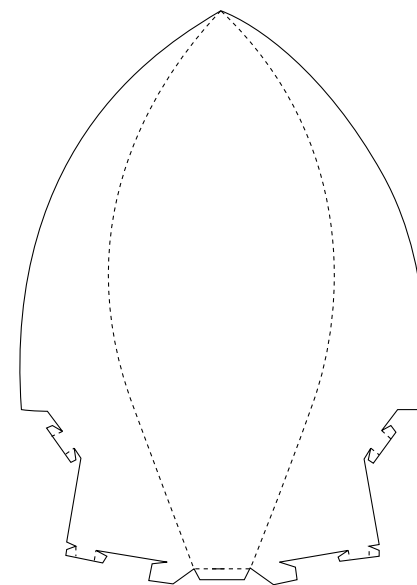

7 elementi paralume n. 4

**Istruzioni di montaggio:**

**I.**

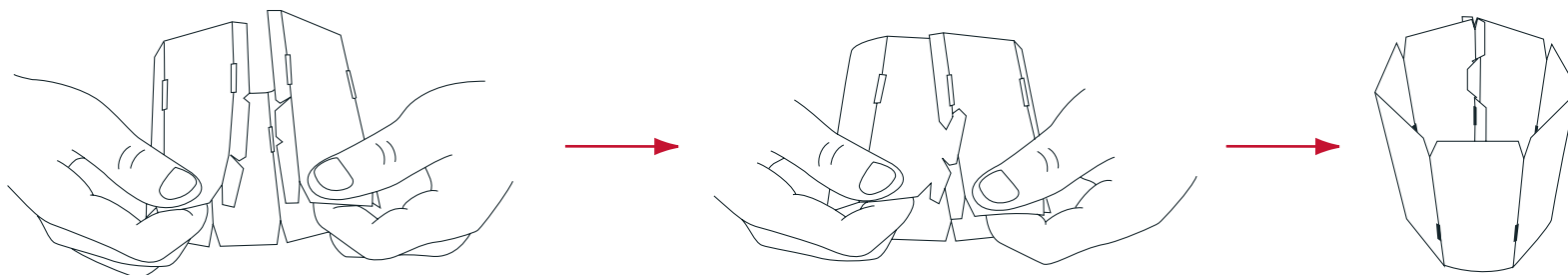

Assemblare la base formando un cilindro con sette lati e lasciando la superficie opaca all'esterno.

2.

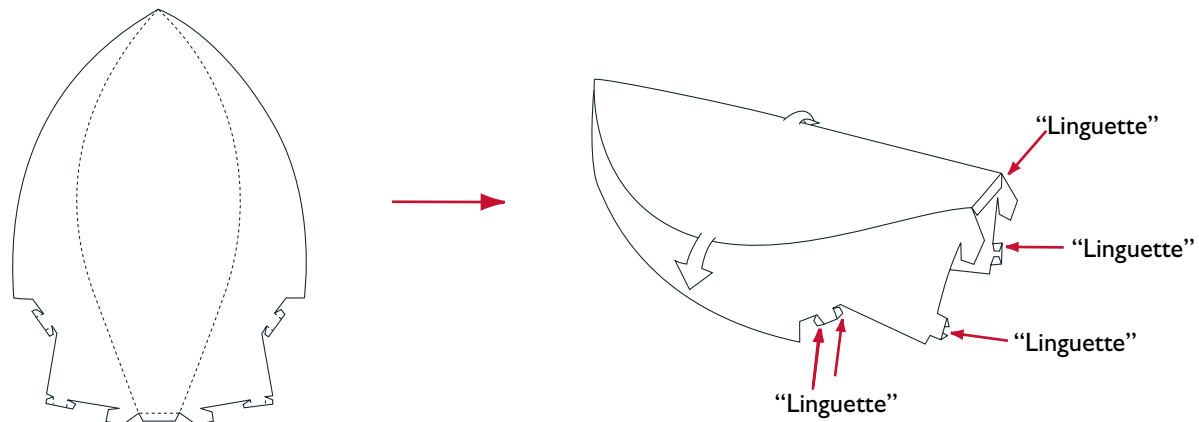

Piegare i 7 elementi paralume contraddistinti dal numero "4" come mostrato in figura. Piegare con cura il lato curvo dell'elemento paralume.

Piegare le "linguette" all'interno lasciando il lato opaco all'esterno.

3.

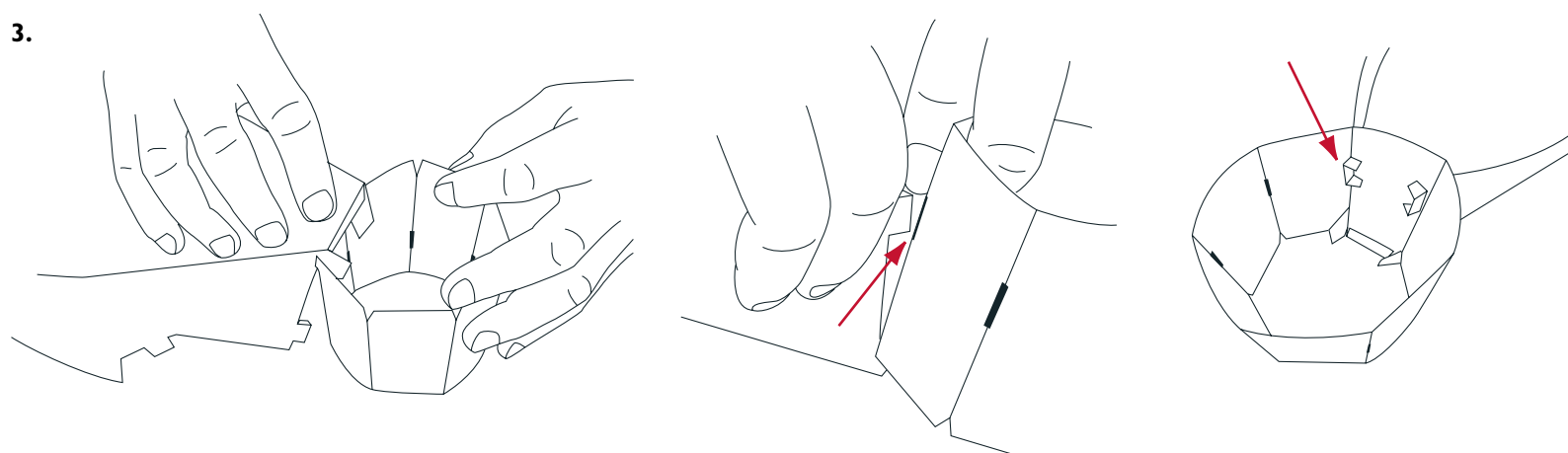

Fissare l'elemento paralume al lato stretto dell'apertura dell'elemento base.

Capovolgere l'elemento base e guidare le "linguette" all'interno delle fessure, piegandole poi sul retro per fissare il modulo.

4.

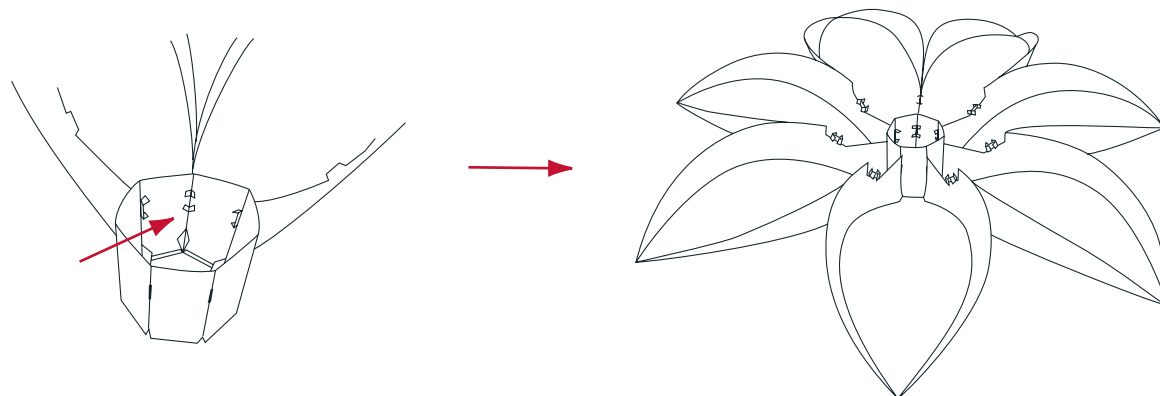

Appoggiare un altro elemento paralume alla base, accanto al primo. Quindi procedere nello stesso modo al montaggio del resto dei 7 elementi paralume n. 4. Non dimenticare di fissare i moduli all'interno della base.

5.

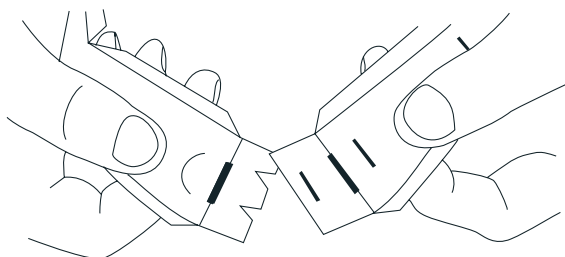

Prendere l'elemento ad anello contraddistinto dalla lettera "L" e piegare i bordi di rinforzo. Montare l'elemento ad anello servendosi delle "linguette".

6.

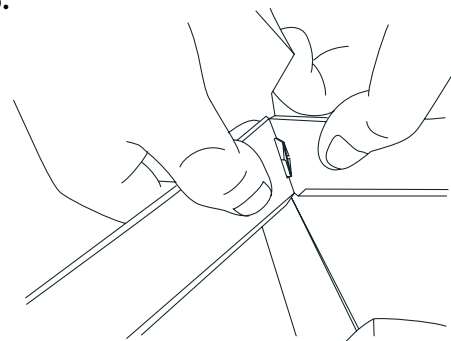

Inserire l'elemento ad anello "L" all'interno delle "linguette" dell'elemento paralume e fissare le "linguette" raddrizzandole.

7.

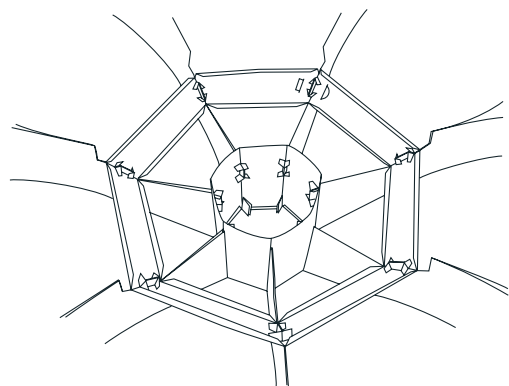

Elemento ad anello correttamente montato.

8.

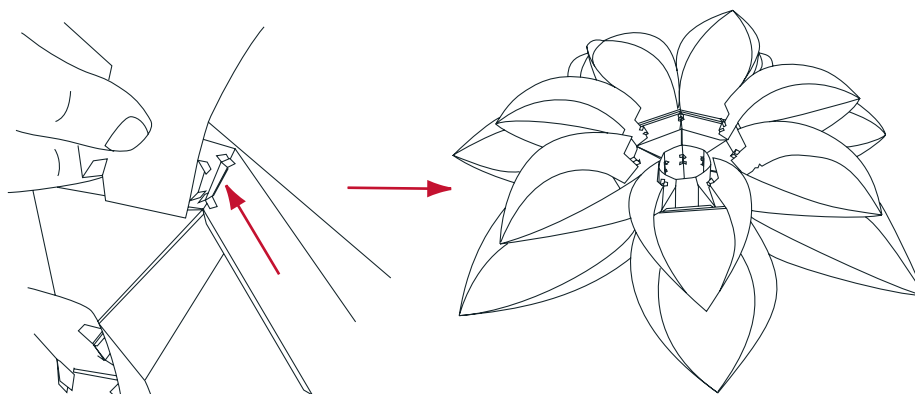

Piegare i 7 elementi paralume contraddistinti dal numero "3". Piegare con cura il lato curvo dell'elemento paralume. Fissare il primo elemento paralume all'elemento ad anello spingendo le "linguette" attraverso la fessura in cui sono state inserite le altre.

Montare il resto degli elementi paralume tutt'intorno nello stesso modo. Non dimenticare di fissare i moduli sul retro.

9.

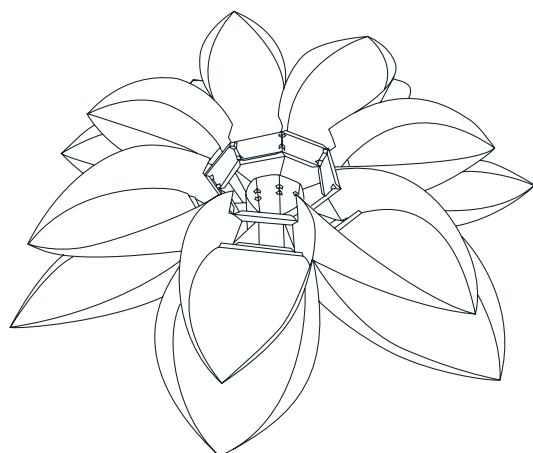

Assemblare e montare l'elemento ad anello "M" sugli elementi paralume contraddistinti dal numero "3".

10.

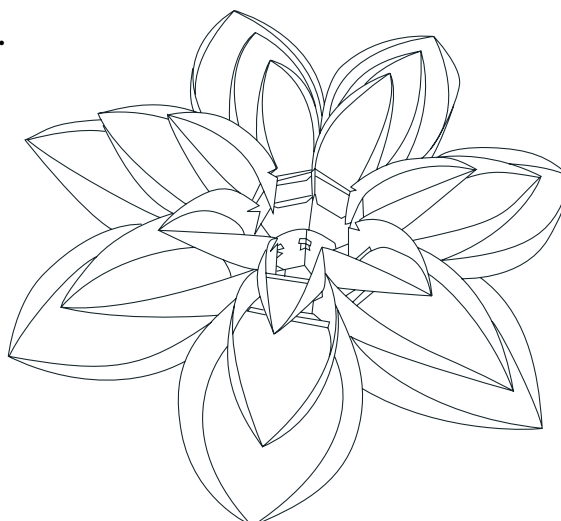

Piegare gli elementi paralume contraddistinti dal numero "2" e montarli tutt'intorno all'elemento "M". Montare l'elemento ad anello "S".

11.

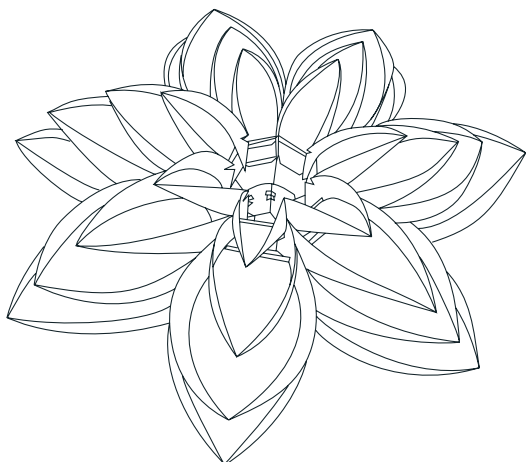

Piegare i 7 elementi paralume contraddistinti dal numero "1" e montarli tutt'intorno all'elemento ad anello "S".

12.

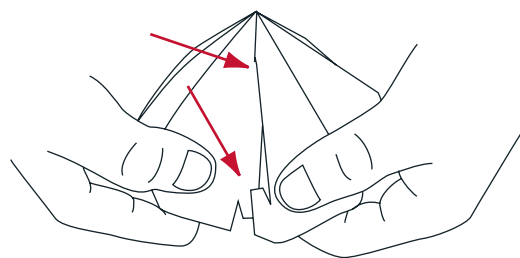

Curvare e assemblare il modulo base. Assicurarsi che le giunture siano rivolte verso l'interno.

13.

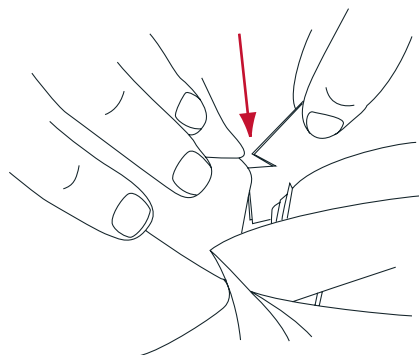

Inserire il modulo base all'interno delle scanalature degli elementi paralume interni. (Le scanalature sono i piccoli tagli).

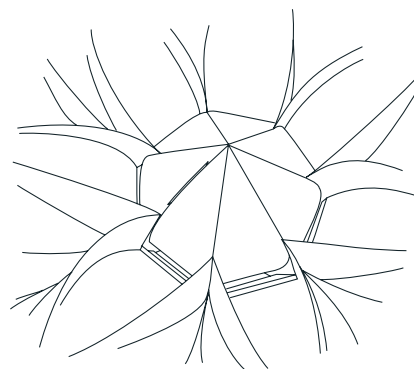

Modulo base completamente montato.

14.

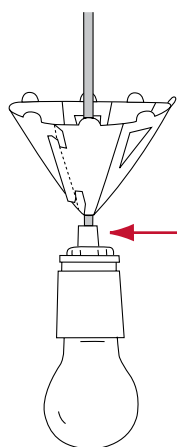

La guarnizione del morsetto DEVE essere montata.

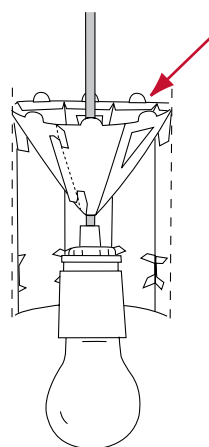

Piegare il modulo di sospensione nelle sei direzioni e assemblarlo intorno ai fili formando un cono con 7 lati.

Ruotare il lampadario in modo tale che l'apertura alla sommità dello stesso sia rivolta verso l'alto. Abbassare il modulo di sospensione all'interno dell'apertura e spingere le "linguette" all'interno delle fessure. Piegare orizzontalmente i bordi di rinforzo così da fissare il modulo di sospensione.

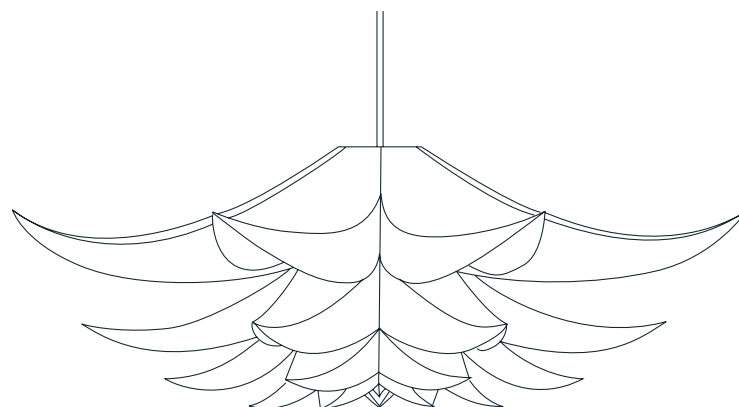

Lampadario completamente montato e pronto per essere appeso. Il lampadario può essere appeso senza necessità di rimuovere il portalamada. Le lampadine possono essere facilmente sostituite tramite la base flessibile del lampadario.

**MAX 60 WATT**

**Inhoud:**

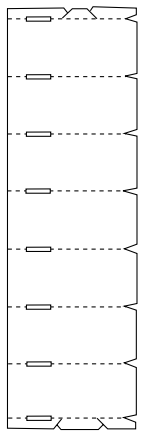

I basiselement

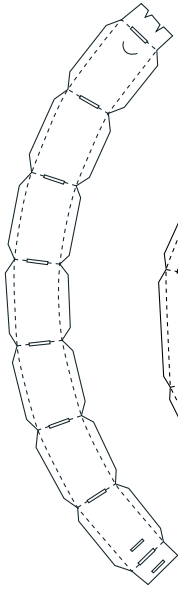

I ringelement S

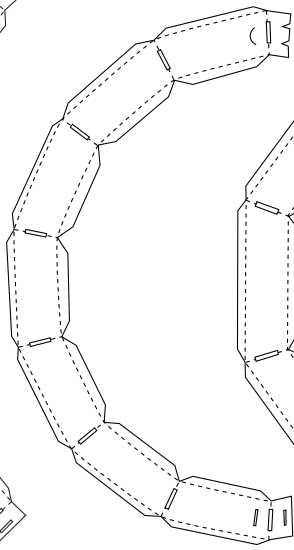

I ringelement M

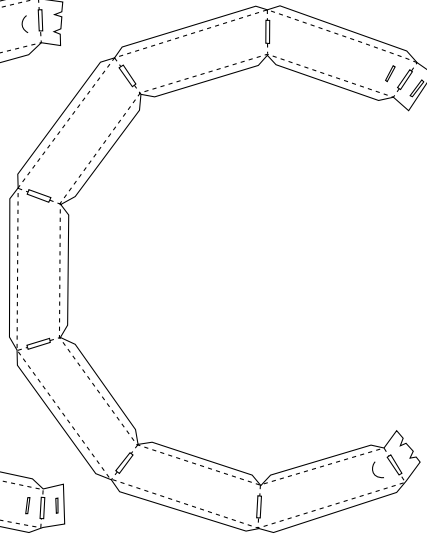

I ringelement L

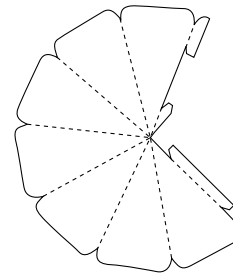

I basismodule

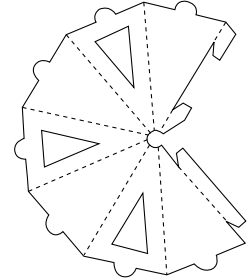

I hangmodule

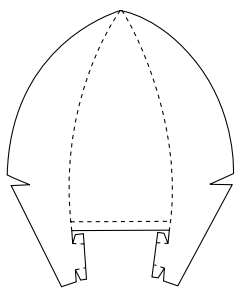

7 lampenkap-elementen nr. 1

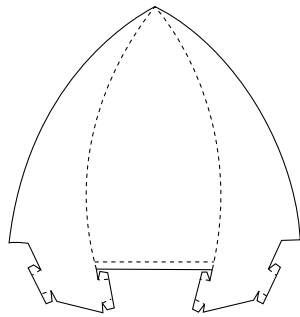

7 lampenkap-elementen nr. 2

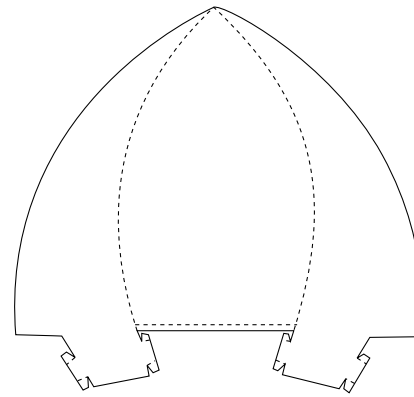

7 lampenkap-elementen nr. 3

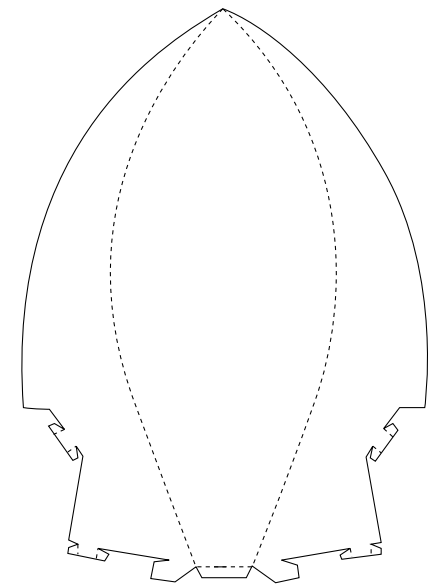

7 lampenkap-elementen nr. 4

**Montage-instructies:**

I.

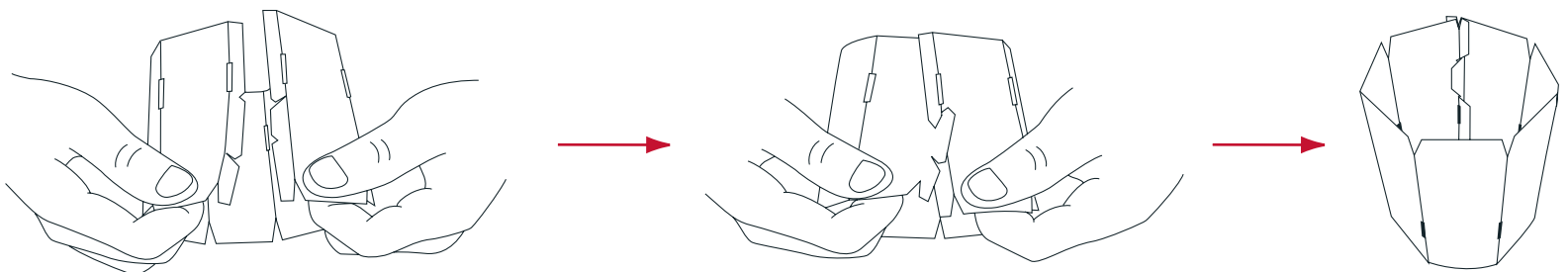

Klik het basiselement met de matte kant naar buiten in elkaar als een zevenkantige cilinder.

2.

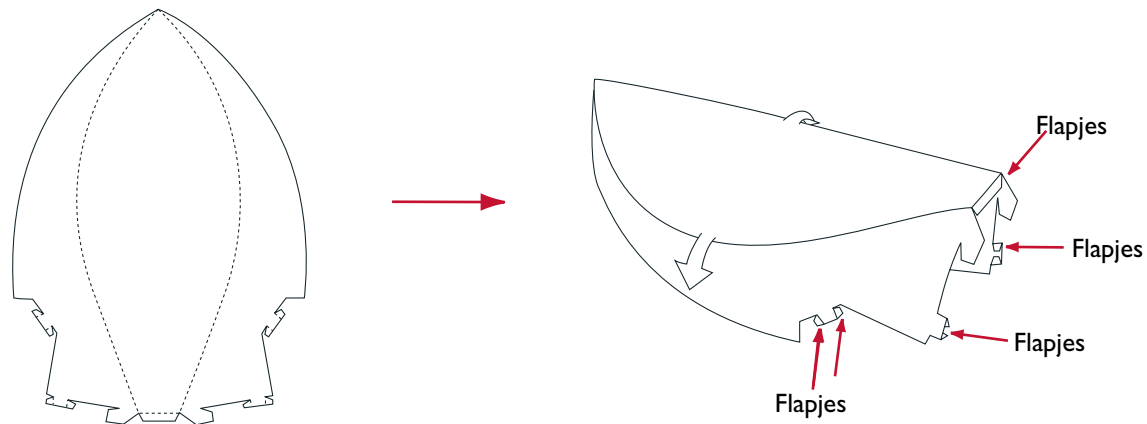

Vouw de 7 lampenkap-elementen met de markering 4 zoals aangegeven. Vouw zorgvuldig langs de kromming van het kap-element.

Vouw de flapjes naar binnen met de matte kant naar buiten.

3.

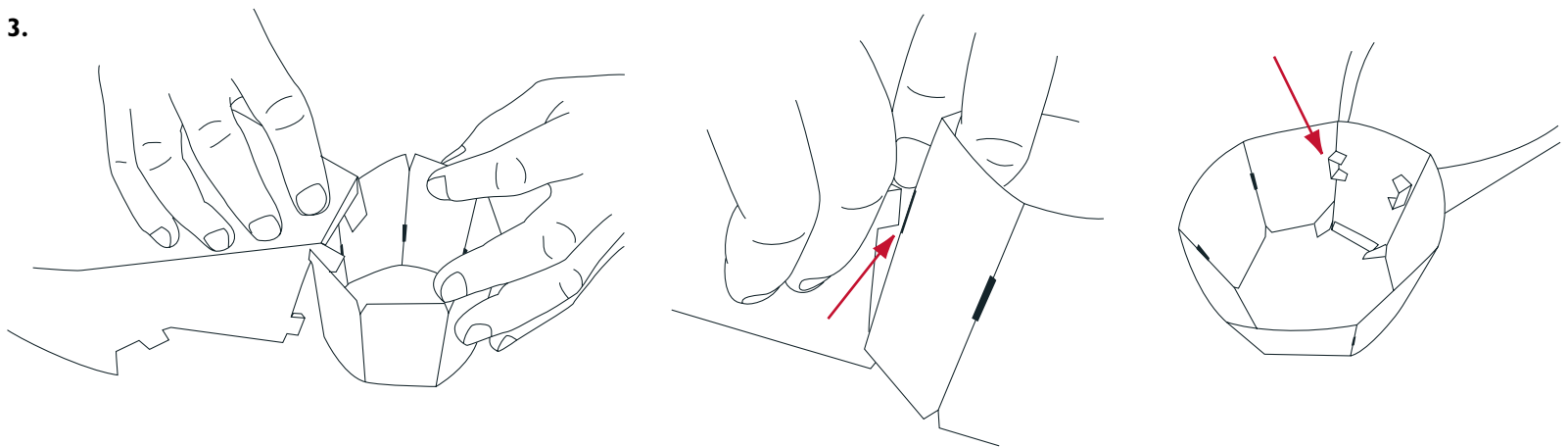

Hang het kap-element op de smalle kant van de opening van het basiselement.

Draai het basiselement om en plaats de flapjes door de openingen. Vouw ze aan de achterkant om om de module vast te zetten.

4.

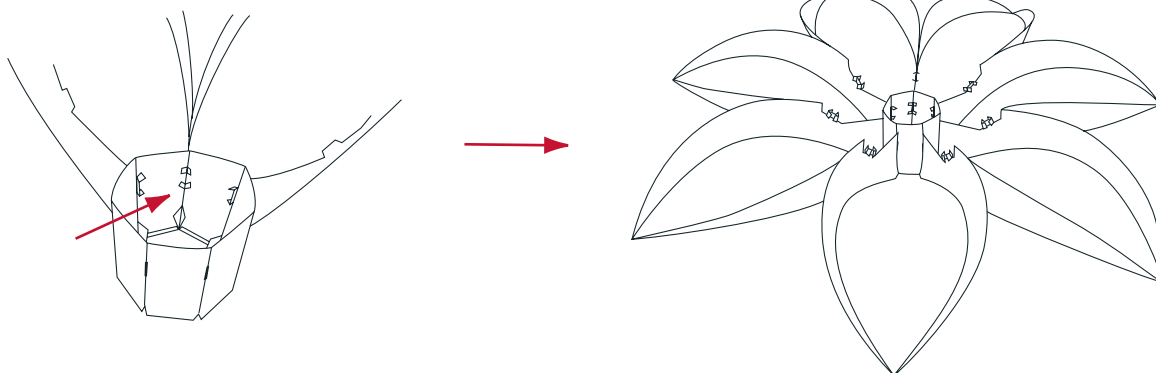

Plaats het volgende kap-element naast het eerste kap-element op het basiselement en ga zo door totdat alle 7 lampenkap-elementen met de markering 4 zijn geplaatst. Zet de modules aan de binnenkant van het basiselement vast.

5.

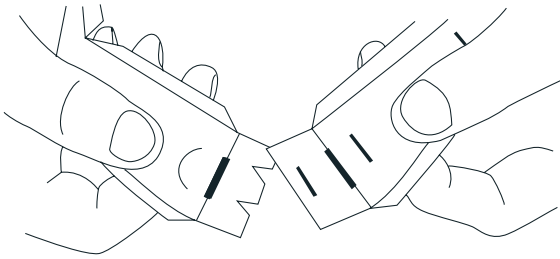

Neem het ringelement met de markering L en vouw de verstevigingsranden om. Zet het ringelement met behulp van de flapjes in elkaar.

6.

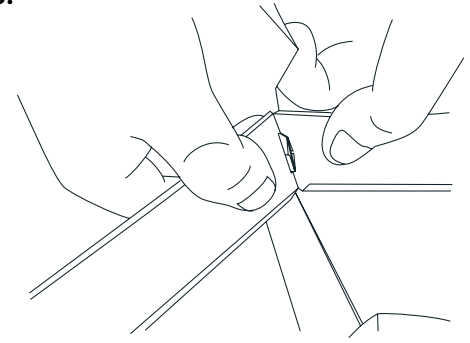

Bevestig ringelement L op de flapjes van het lampenkap-element en zet ze vast door de flapjes recht te buigen.

7.

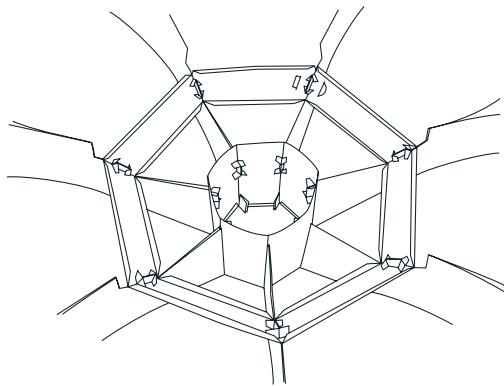

Het correct bevestigde ringelement.

8.

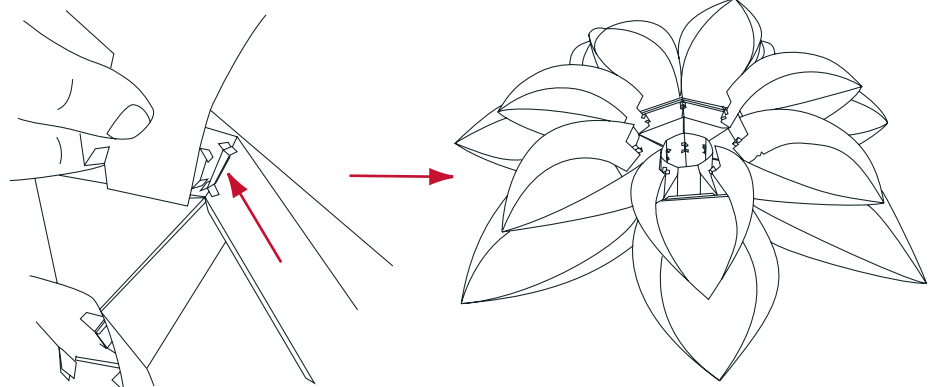

Vouw de 7 lampenkap-elementen met de markering 3. Vouw zorgvuldig langs de kromming van het kap-element. Bevestig het eerste kap-element aan het ringelement door de flapjes door de opening te duwen waar zich ook de andere flapjes bevinden.

Bevestig op dezelfde manier de andere lampenkap-elementen. Vergeet niet de modules aan de achterkant vast te zetten.

9.

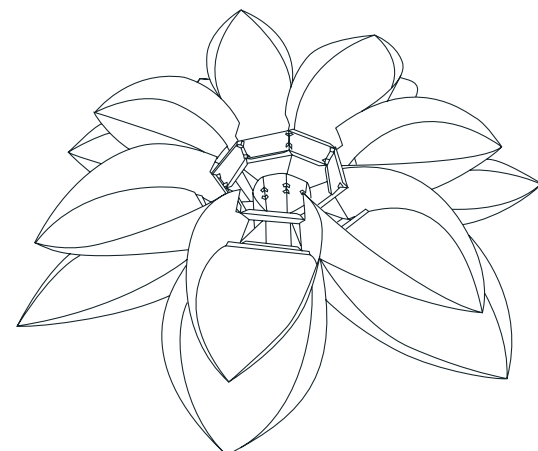

Zet ringelement M in elkaar en plaats het op de lampenkap-elementen met de markering 3.

10.

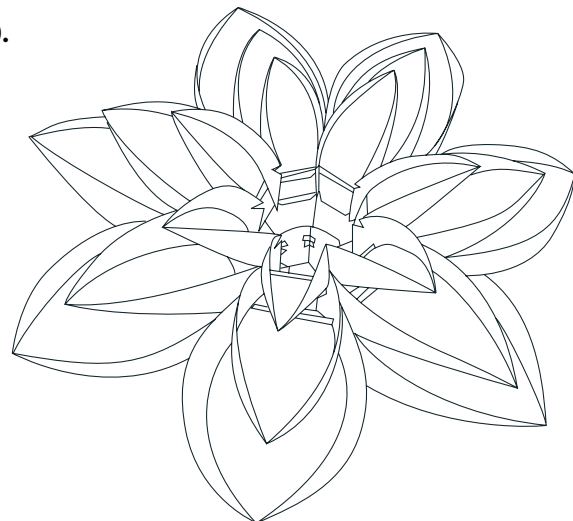

Vouw de lampenkap-elementen met de markering 2 en plaats ze rondom op ringelement M. Bevestig ringelement S.

11.

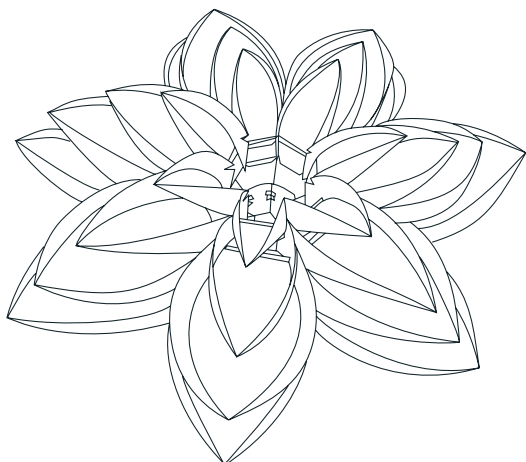

Vouw de lampenkap-elementen met de markering I en plaats ze rondom op ringelement S.

12.

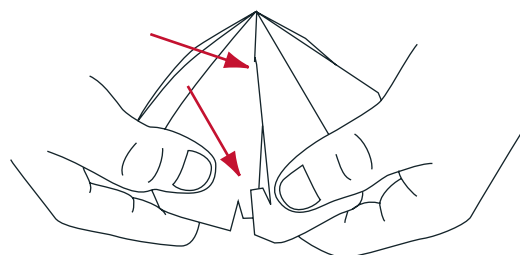

Buig de basismodule om en zet deze in elkaar met de bevestigingspunten naar binnen.

13.

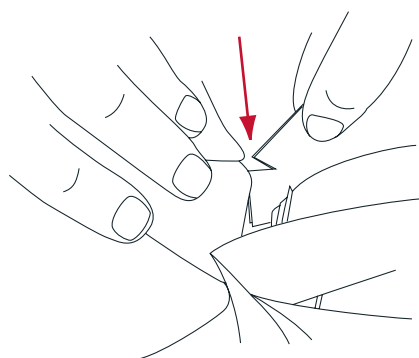

Plaats de basismodule in de sleuven in de binnenste lampenkap-elementen (de sleuven zijn kleine inkepingen).

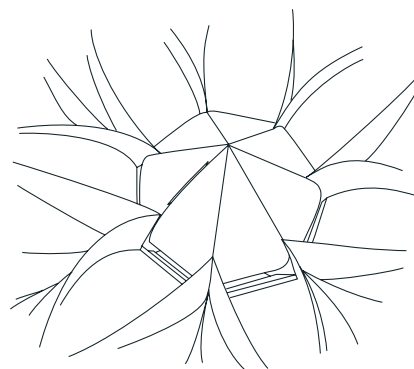

De volledig gemonteerde basismodule.

14.

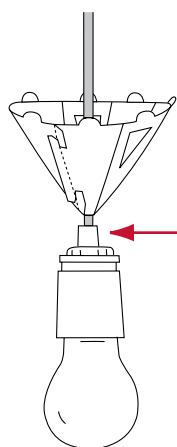

Er MOET een klemnippel zijn geplaatst.

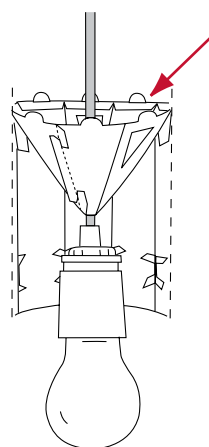

Buig de hangmodule in de zes richtingen en plaats deze als een zevenkantige kegel aan het snoer.

Draai de lamp om zodat de opening aan de bovenkant van de lamp naar boven wijst. Laat de hangmodule in de opening zakken en duw de flapjes door de gaten. Buig de verstevigingsranden horizontaal omlaag om de hangmodule vast te zetten.

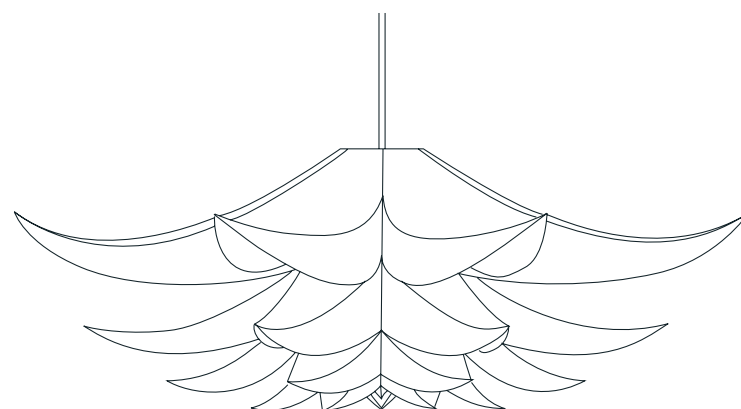

De volledig gemonteerde lamp, klaar om op te hangen. U hoeft de lampfitting niet te verwijderen om de lamp op te hangen. De gloeilamp is eenvoudig te verwisselen via de flexibele onderkant van de lamp.

**MAX 60 WATT**



**Componentes:**

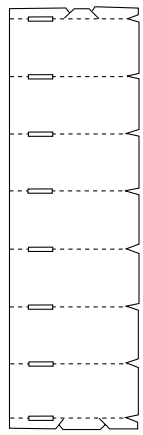

I elemento base

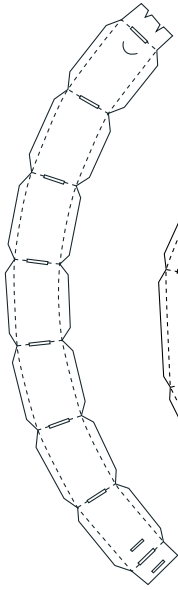

I elemento do anel S

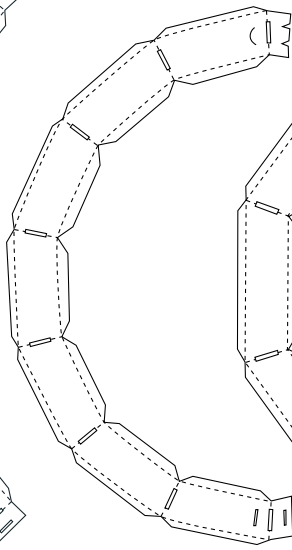

I elemento do anel M

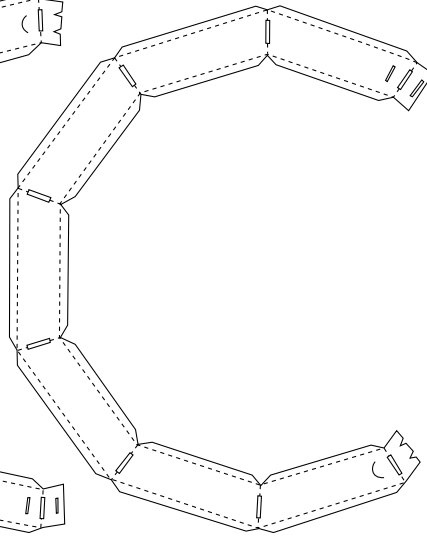

I elemento do anel L

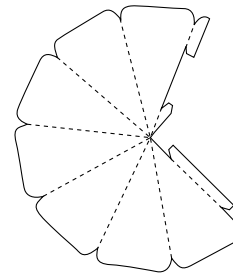

I módulo base

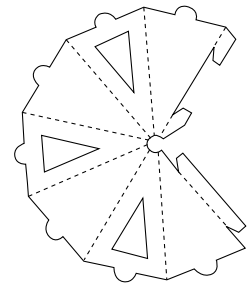

I módulo de suspensão

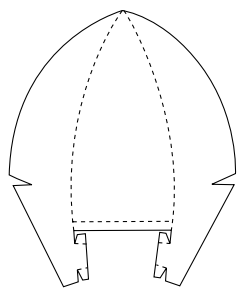

7 elementos do abajur n.º 1

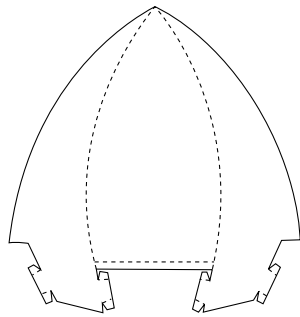

7 elementos do abajur n.º 2

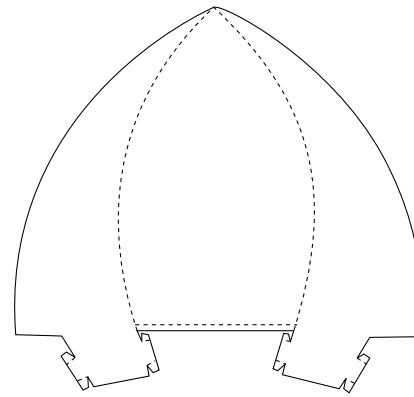

7 elementos do abajur n.º 3

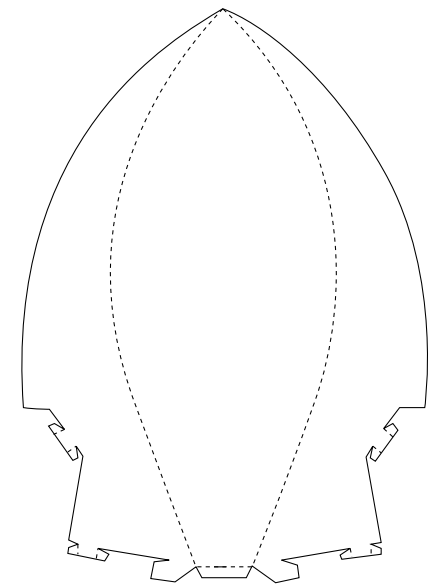

7 elementos do abajur n.º 4

**Instruções de montagem:**

I.

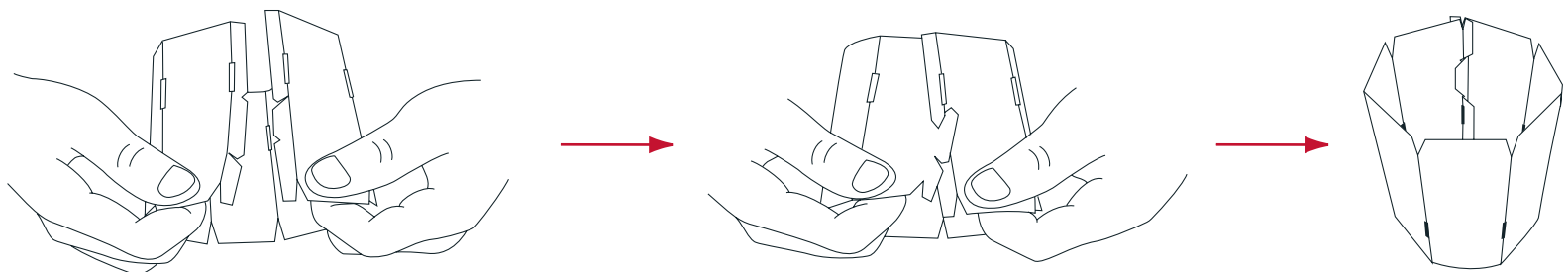

“Dobre” a base num cilindro com 7 lados, com a parte mate para fora.

## INSTRUÇÕES DE MONTAGEM NORM 06 LARGE/PORTUGUÊS

2.

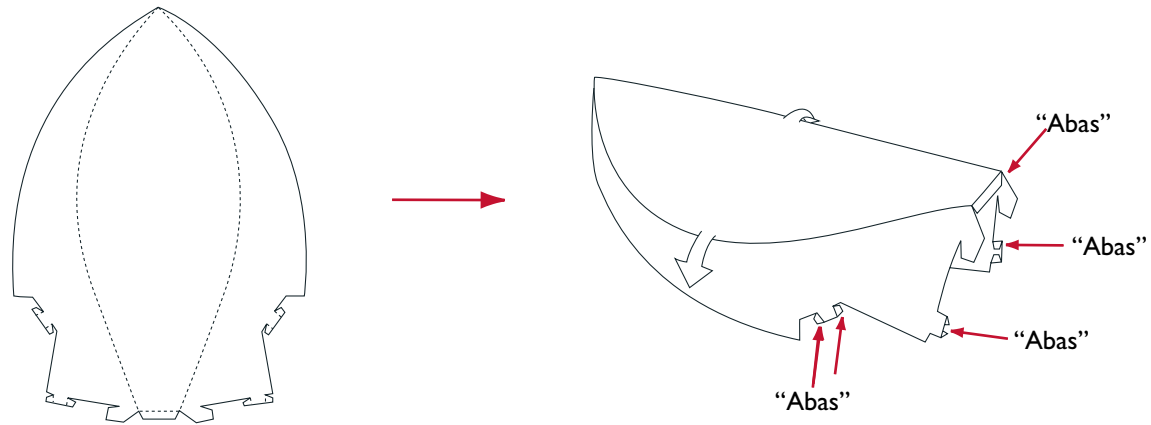

Dobre os 7 elementos do abajur assinalados como “4” conforme se ilustra. Dobre cuidadosamente ao longo do elemento do abajur.

Dobre as “abas” para dentro, com o lado mate para fora.

3.

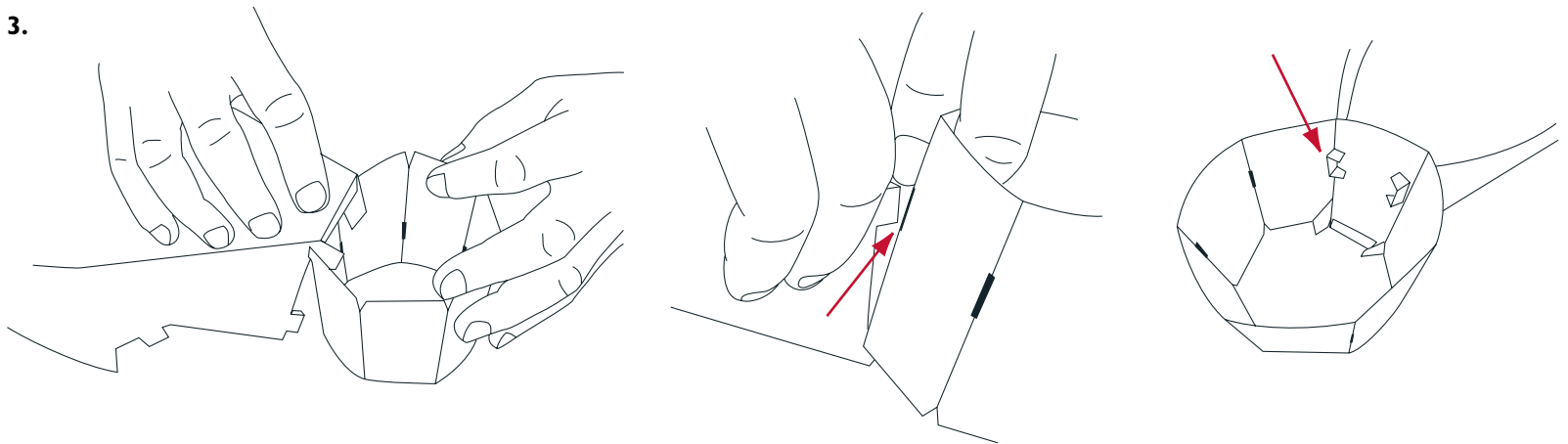

Engate o elemento do abajur na parte estreita da abertura no elemento base.

Vire o elemento base ao contrário e insira as “abas” nos orifícios, dobrando-as na parte de trás para apertar o módulo.

4.

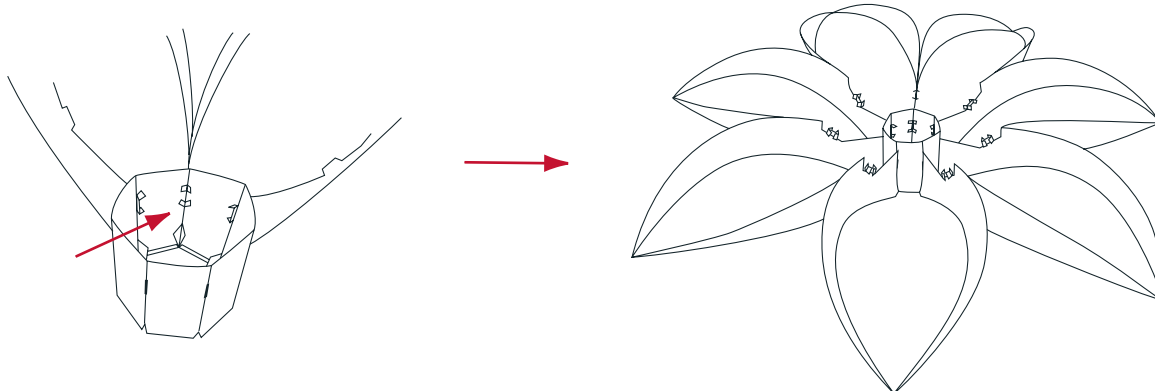

Coloque o elemento seguinte do abajur na base, junto ao primeiro, e continue até que todos os 7 elementos do abajur assinalados como n.º 4 estejam colocados. Lembre-se de apertar os módulos no interior da base.

5.

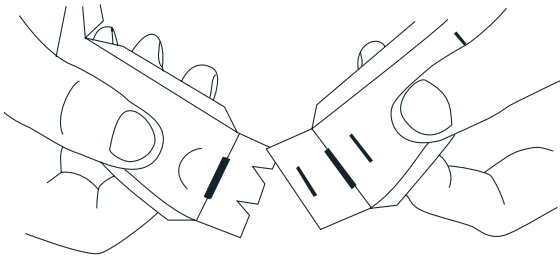

Pegue no elemento do anel assinalado como "L" e dobre as extremidades uma sobre a outra. Instale o elemento do anel usando as "abas".

6.

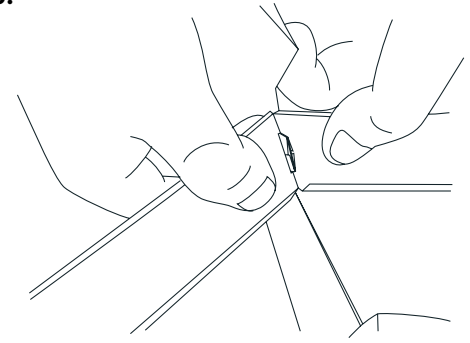

Insira o elemento do anel "L" nas "abas" do elemento de abajur e aperte-os endireitando as "abas".

7.

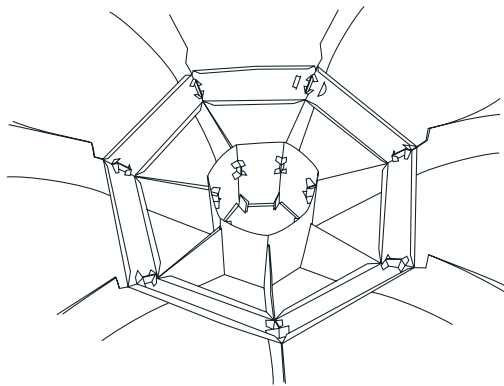

Elemento do anel correctamente montado.

8.

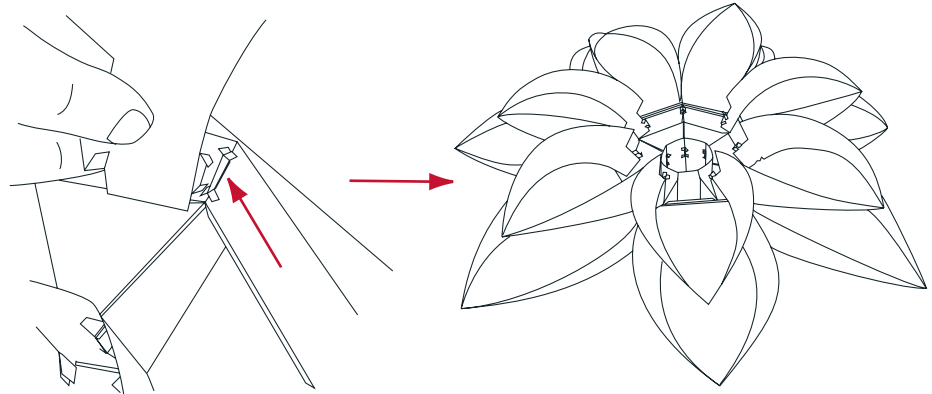

Dobre os 7 elementos do abajur assinalados como "3". Dobre cuidadosamente sobre a curva do elemento do abajur. Coloque o primeiro elemento do abajur sobre o elemento do anel inserindo as "abas" no orifício em que se encontram as outras "abas".

Monte de forma idêntica os restantes elementos do abajur a toda a volta. Não se esqueça de prender os módulos na parte de trás.

9.

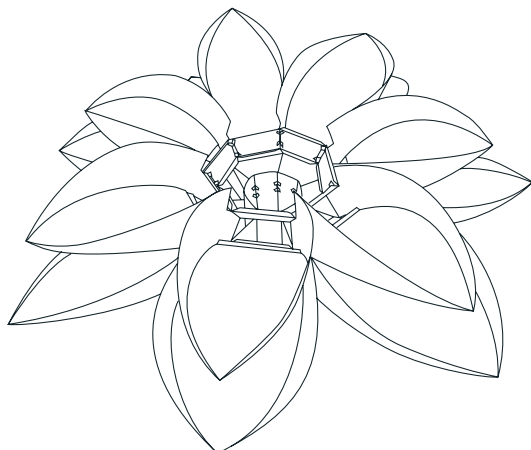

Instale e monte o elemento do anel "M" nos elementos do abajur assinalados como "3".

10.

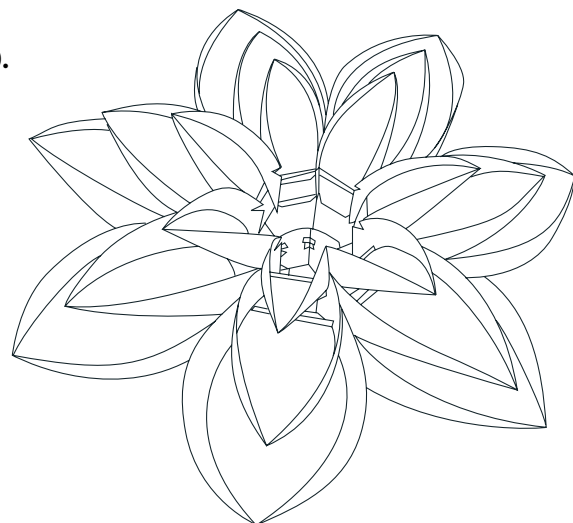

Dobre os elementos do abajur assinalados como "2" e monte-os no elemento do anel "M" a toda a volta. Monte o elemento do anel "S".

## INSTRUÇÕES DE MONTAGEM NORM 06 LARGE/PORTUGUÊS

11.

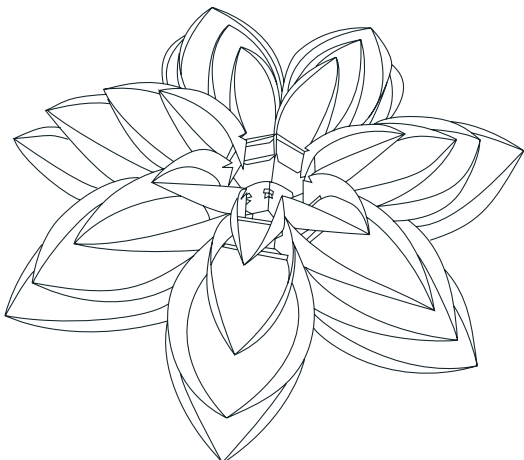

Dobre os 7 elementos do abajur assinalados como "1" e monte-os no elemento do anel "S" a toda a volta.

12.

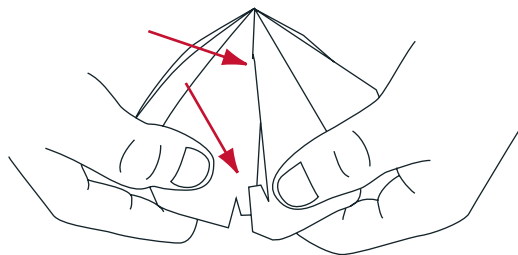

Curve e instale o módulo base. Verifique se as juntas estão viradas para dentro.

13.

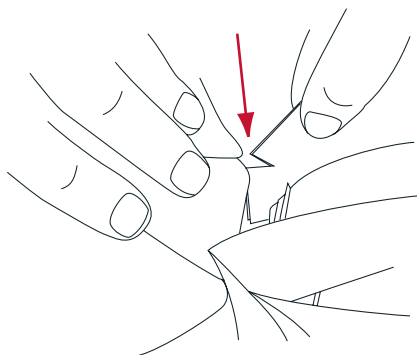

Insira o módulo base nas ranhuras dos elementos internos do abajur. (As ranhuras são os pequenos cortes).

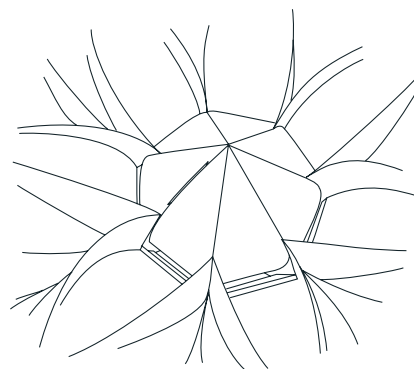

O módulo base totalmente montado.

14.

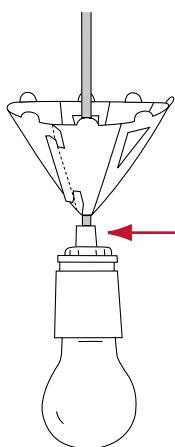

O gancho da ponta DEVE ser montado.

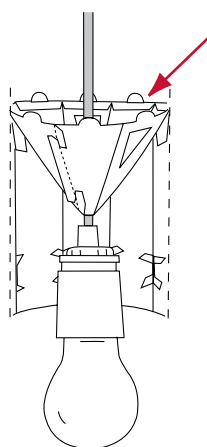

Dobre o módulo de suspensão nas 6 partes e instale-o à volta dos fios para formar um cone com 7 lados.

Rode o candeeiro para que a abertura na parte de cima fique virada para cima. Desça o módulo de suspensão e insira as "abas" nos orifícios. Posicione as extremidades horizontalmente para apertarem o módulo de suspensão.

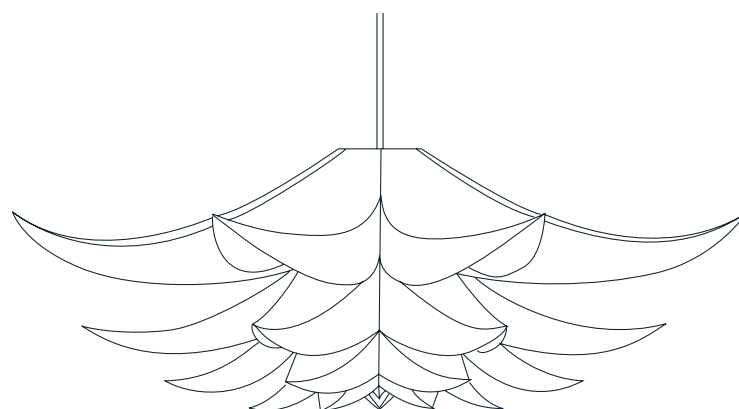

O candeeiro totalmente instalado e pronto para ser suspenso. O candeeiro pode ser suspenso sem retirar a ligação eléctrica. As lâmpadas podem ser trocadas facilmente através da base flexível do candeeiro.

**MAX 60 WATT**

内容:

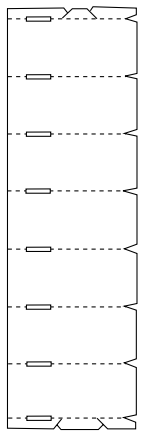

ベースエレメント1個

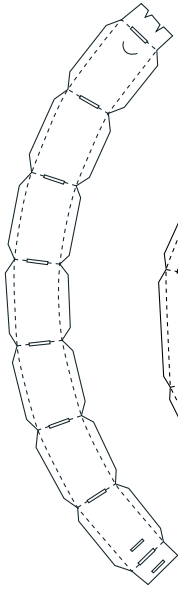

リングエレメント S1 個

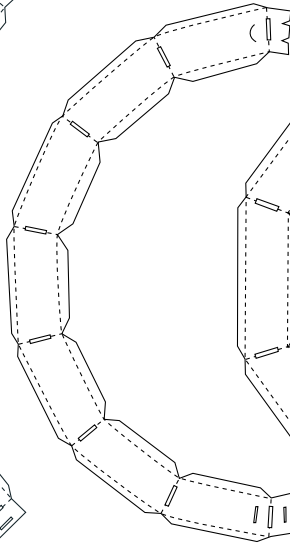

リングエレメント M1 個

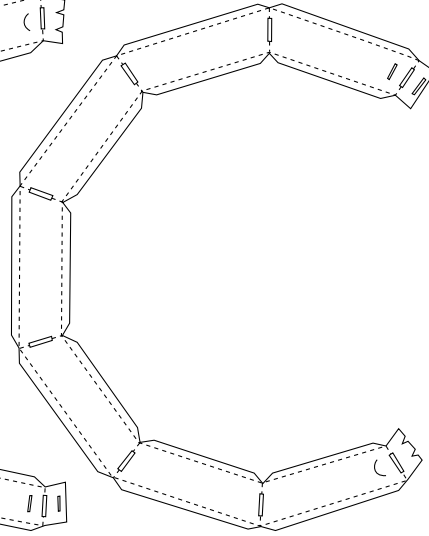

リングエレメント L1 個

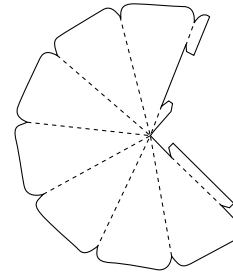

ベースモジュール1個

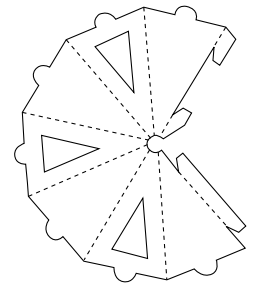

サスペンションモジュール1個

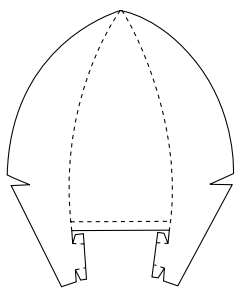

ランプシェードエレメント (no. 1) 7 個

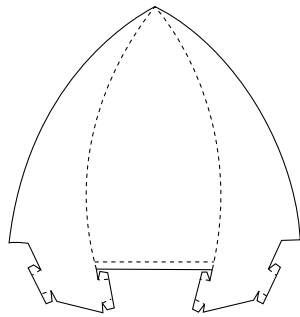

ランプシェードエレメント (no. 2) 7 個

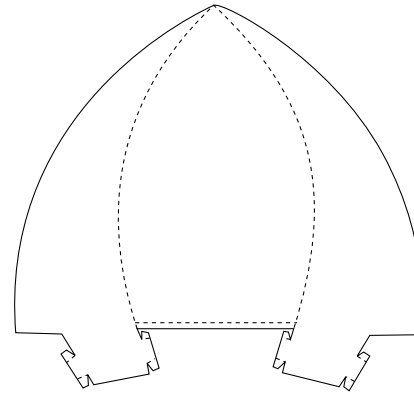

ランプシェードエレメント (no. 3) 7 個

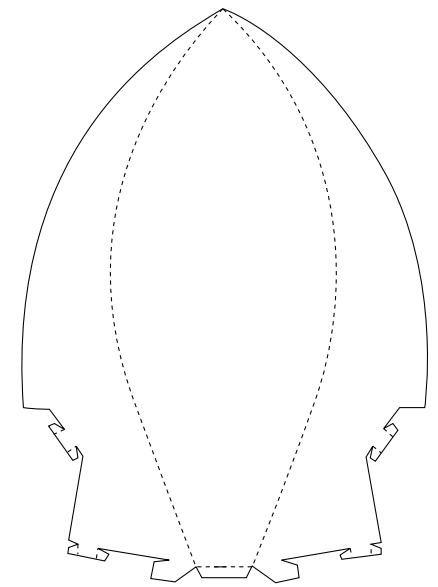

ランプシェードエレメント (no. 4) 7 個

組み立て方:

1.

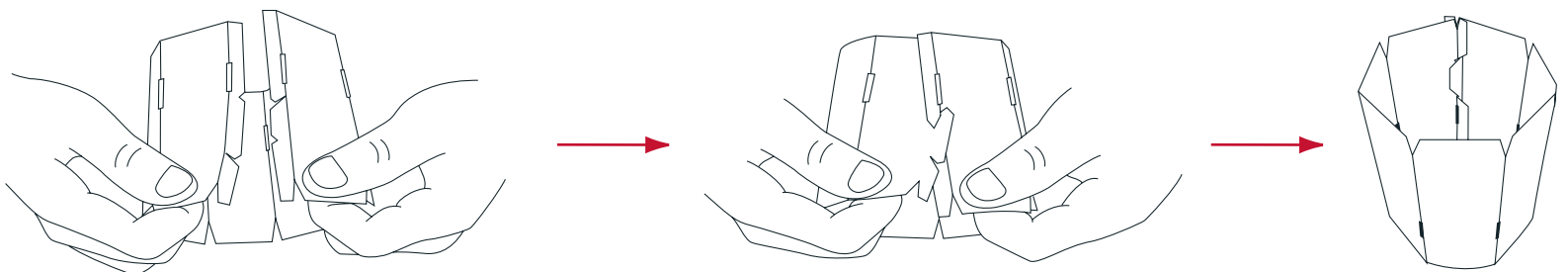

マット面を外側にして、ベースエレメントを「パチッ」と音がするまではめ込みます。

- 使用中に異臭や異常が感じられた場合、すぐに使用をやめ、電球が本体に接触していないか確認してください。
- ・ 電球の交換は電源を切ってから行ってください。
- ・ つりさげた状態で、本体を揺らしたり持ち上げたりしないでください。
- ・ 本製品はプラスチックシートでできていますので、使用頻度や年月により硬化しますので、折り曲げ部分が弱くなる場合があります。
- ・ 白熱球をご使用になりますと、土台部分に熱を持ち、パーツが変形したり火災の原因となります。危険ですので、必ず **E26口金13W以下の蛍光灯** をご使用ください。上記以外の電球を使用時に起きた不具合につきましては、対応いたしかねますので、予めご了承ください。

2.

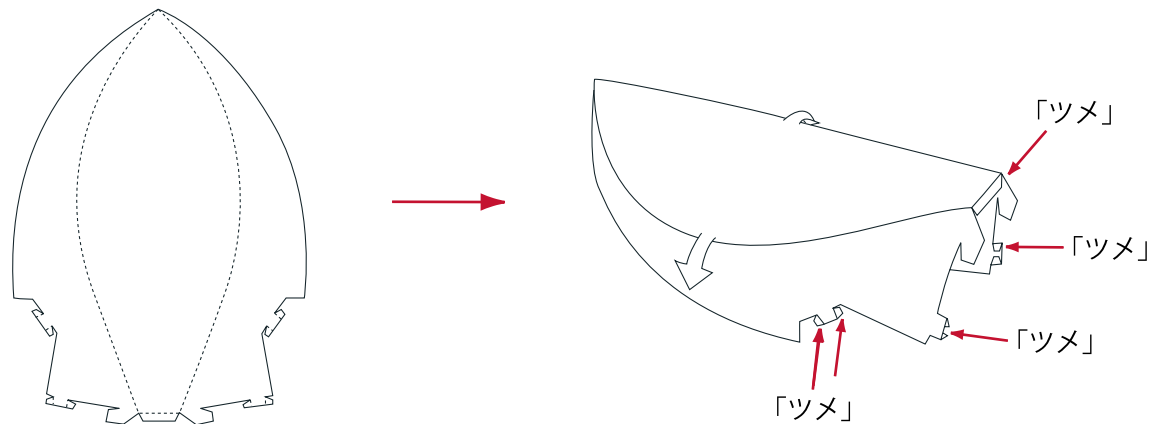

ランプシェード エLEMENT (no.4) 7個を折ります。シェード エLEMENTの形に合わせて折ってください。

マット面を外側にして、図の様に「ツメ」の部分を折り返します。

3.

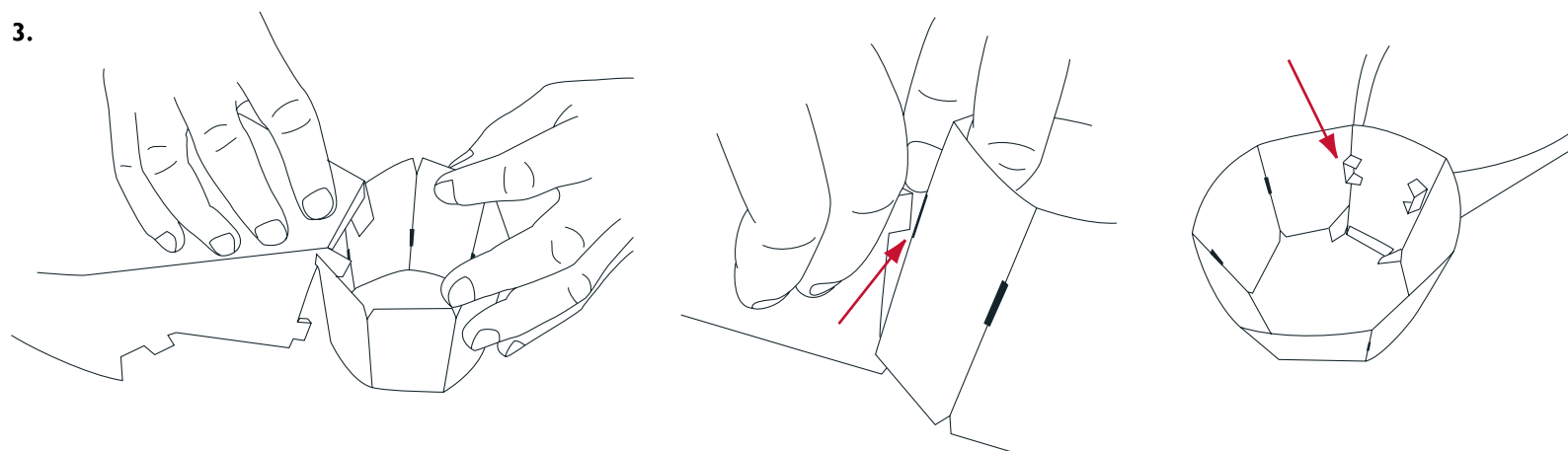

シェード エLEMENTを、ベース エLEMENTの狭い方の開口部にひっかけます。

ベース エLEMENTを上下逆さにして、「ツメ」を穴に通して裏側で折り、モジュールを固定します。

4.

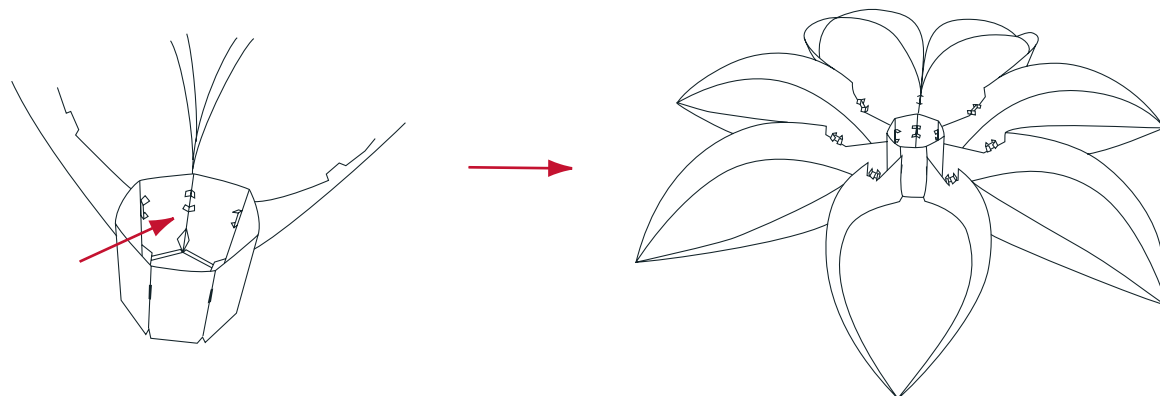

次のシェード エLEMENTをベースに置いて、同じ手順を繰り返します。ランプシェード エLEMENT (no.4) 7個をすべて取り付けます。モジュールは、必ずベースの内側で固定してください。

5.

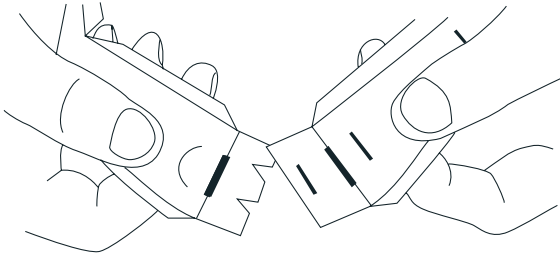

リングエレメント(L)の両端を折り、ツメを差し込みリングエレメントを組み立てます。

6.

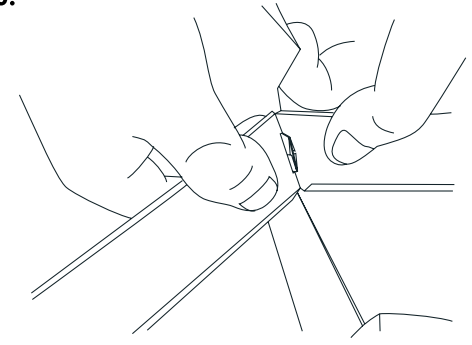

リングエレメント(L)をランプシェードエレメントの「ツメ」に合わせ、折り返した「ツメ」をまっすぐに開いて固定します。

7.

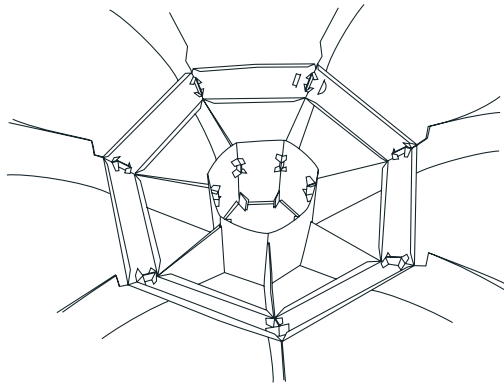

リングエレメントが正しく取り付けられた状態。

8.

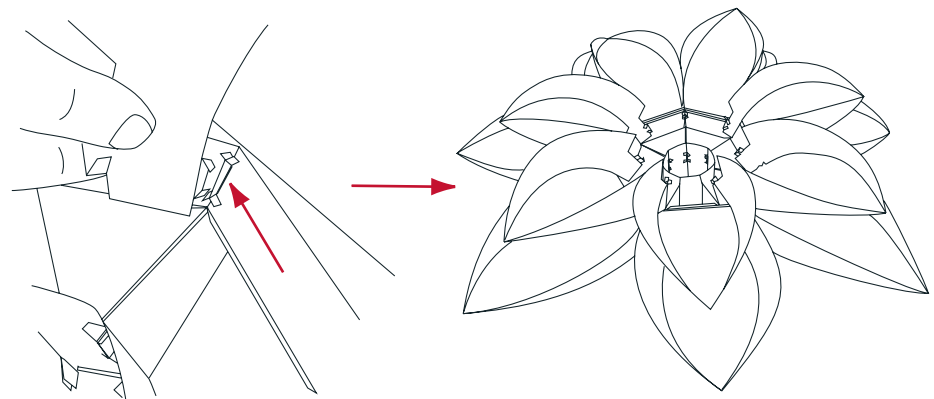

ランプシェードエレメント(no.3)7つを折ります。シェードエレメントの形にそって折って下さい。シェードエレメントをリングエレメントに置き、一方の「ツメ」をもう一方の「ツメ」がある穴に通します。

同じように、残りのランプシェードエレメントを取り付けます。モジュールは、必ず裏側で固定してください。

9.

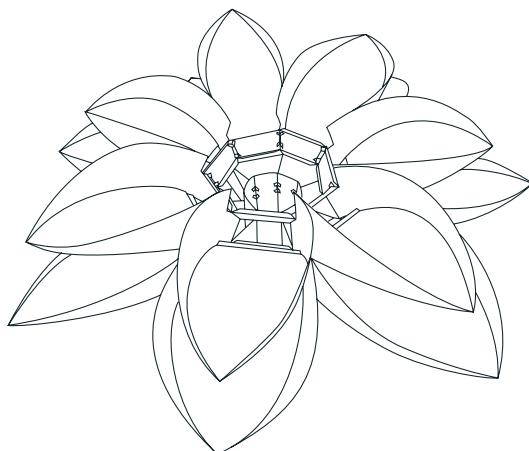

リングエレメント(M)を組み立て、ランプシェードエレメント(no.3)に取り付けます。

10.

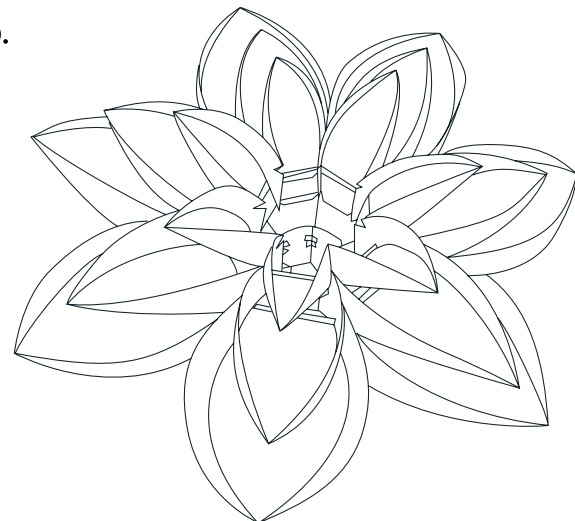

ランプシェードエレメント(no.2)を折り、リングエレメント(M)の周りを取り付けます。リングエレメント(S)を取り付けます。

11.

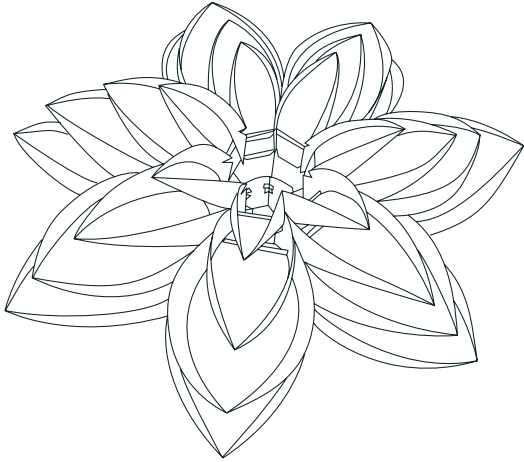

ランプシェード エレメント (no. 1) 7個を折り、リング エレメント (S) の周りに取り付けます。

12.

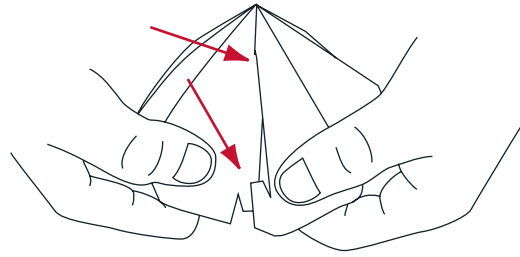

ベースモジュールを折り、ツメが内側になるように組み立てます。

13.

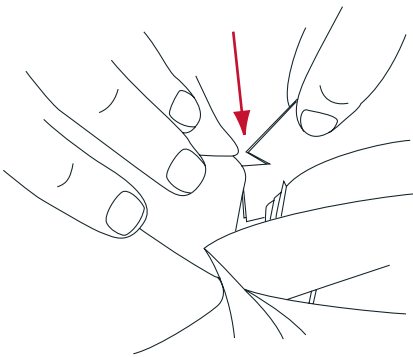

ベース モジュールを、ランプシェード エレメント内側にある切れ目にはめ込みます。(切れ目は小さな切り込みです)。

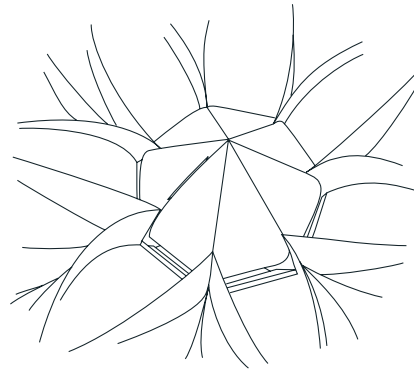

ベース モジュールを完全に組み立てます。

14.

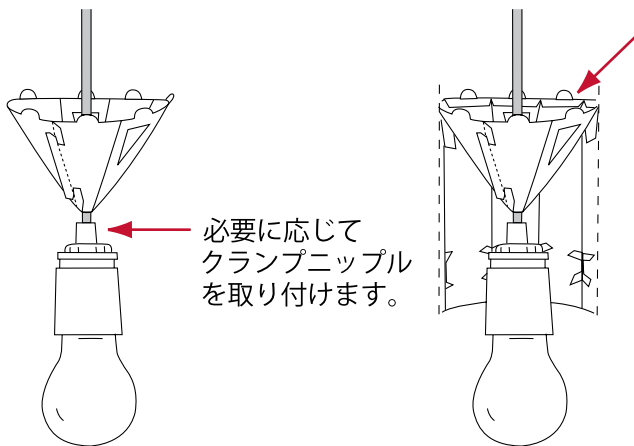

必要に応じて  
クランプニップル  
を取り付けます。

サスペンションモジュールを折り、コードに取り付け、図のようにツメを組み合わせます。モジュールは7面の円すい状になります。

組み上がったランプシェード上部の開口部を上向きにします。サスペンションモジュールを開口部から下げ入れ、丸形のツメを穴に通します。図の矢印が指している部分のように端部のツメを内側に折り、サスペンションモジュールを固定します。

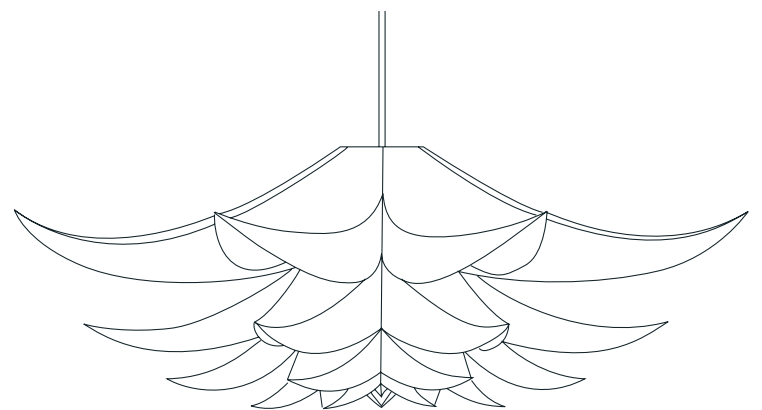

組み立ては終了です。電球はベースモジュールを取り外すことによって簡単に交換出来ます。

**最大13ワット**  
**(白熱球のご使用はお止め下さい。)**



내용물:

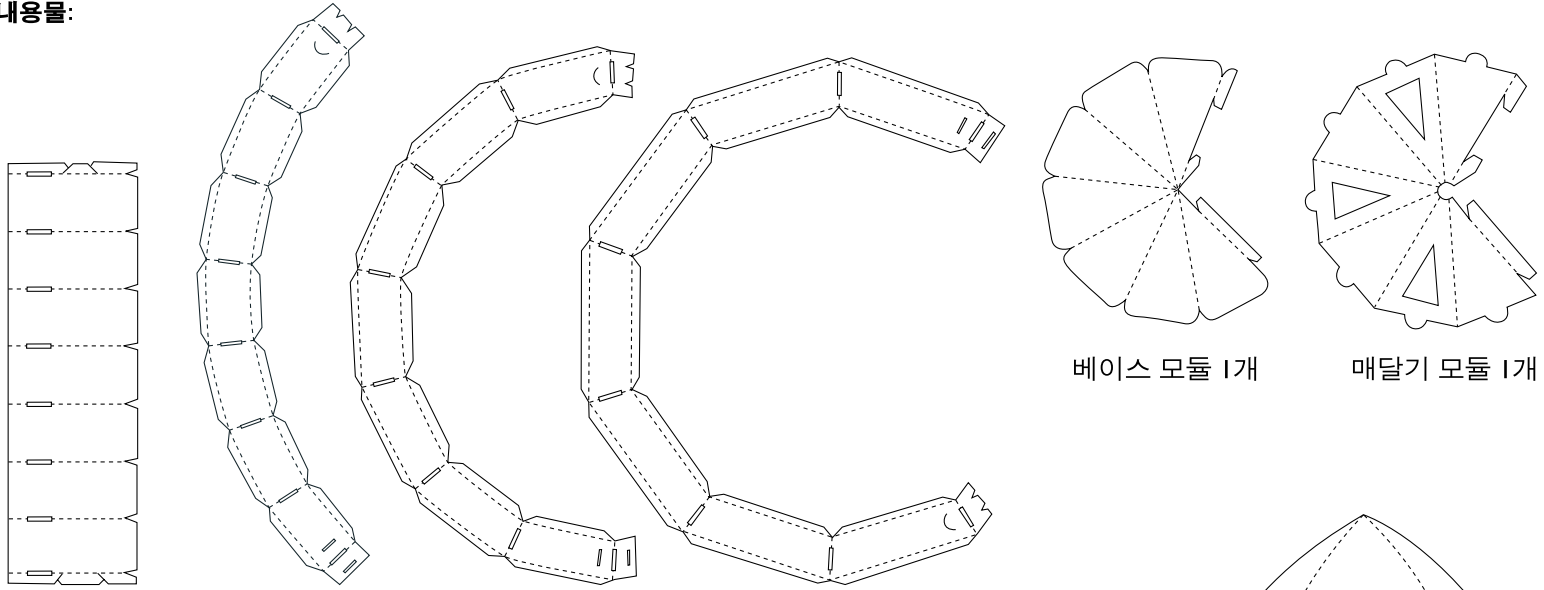

베이스 구성요소 1개

링 구성요소 S 1개

링 구성요소 M 1개

링 구성요소 L 1개

베이스 모듈 1개

매달기 모듈 1개

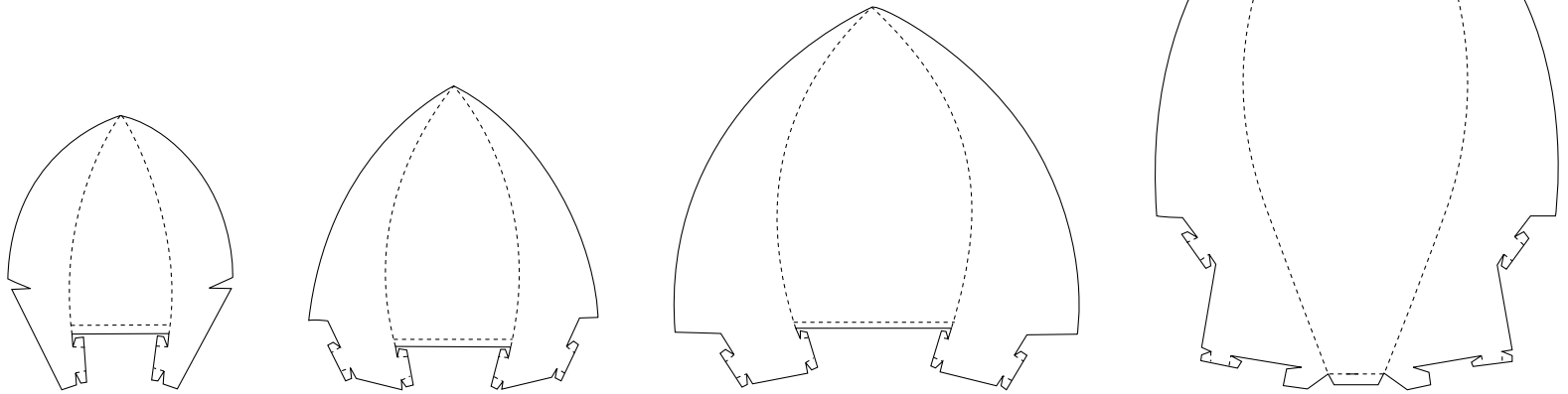

1번 전등갓 구성요소 7개

2번 전등갓 구성요소 7개

3번 전등갓 구성요소 7개

4번 전등갓 구성요소 7개

조립 안내:

I.

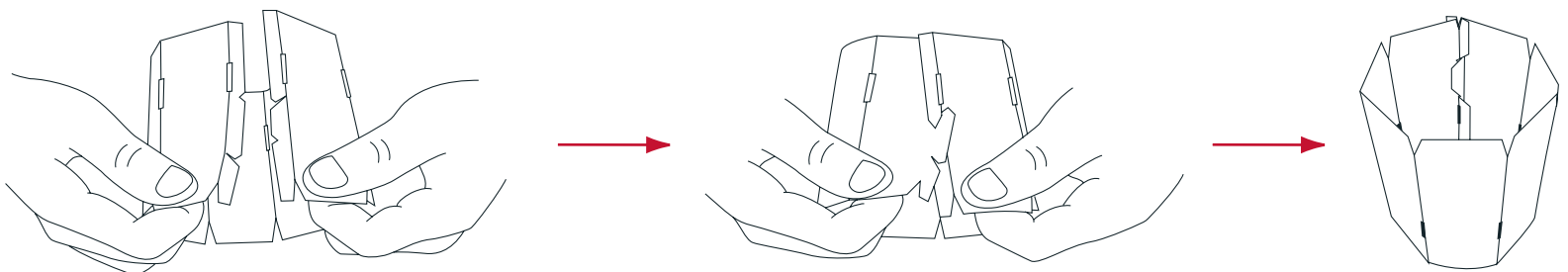

무광택면을 밖으로 7면 원통이 되도록 밀면을 서로 '맞물리게 한다'.

조립 안내 NORM 06 LARGE/한국어

2.

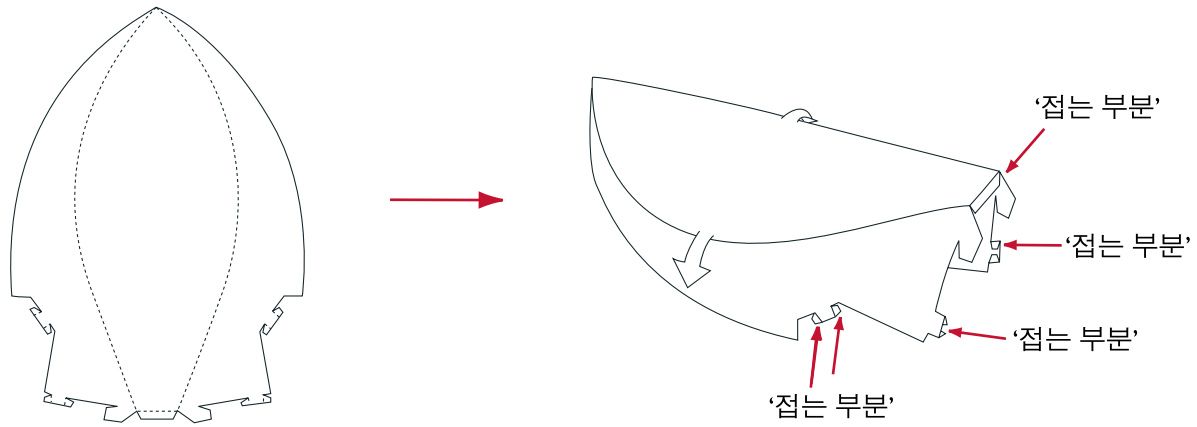

그림처럼 4번 전등갓 구성요소를 7개 접는다. 갓 구성요소의 곡선을 따라 조심스럽게 접는다.

무광택면을 밖으로 '접는 부분'을 접는다.

3.

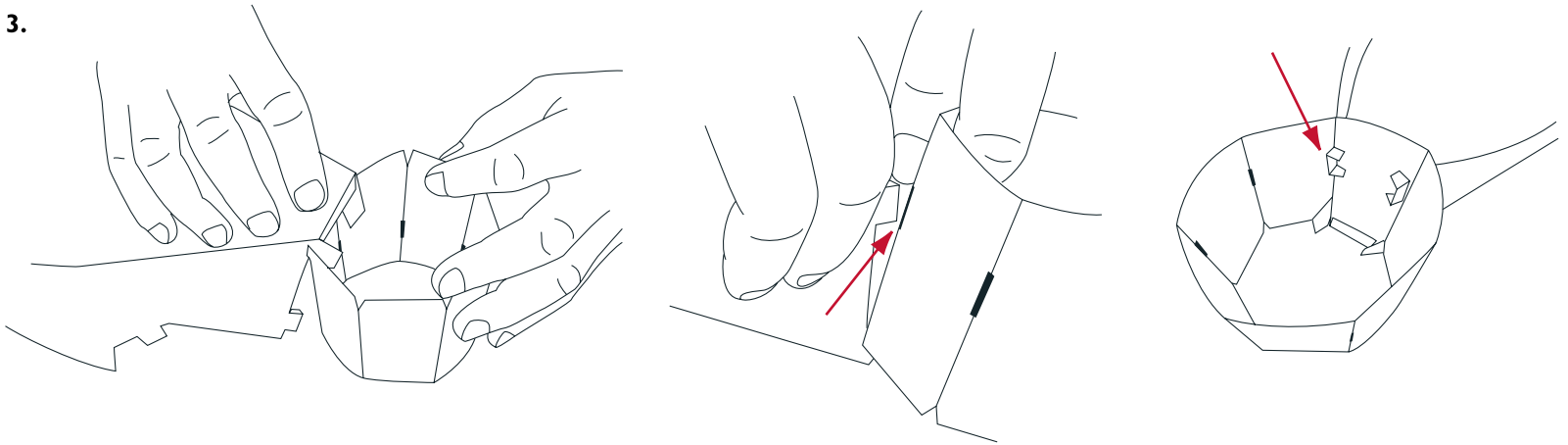

베이스 구성요소에 있는 틈의 좁은 부분에 갓 구성요소를 끼운다.

베이스 구성요소의 위쪽이 아래로 향하도록 뒤집고 구멍을 지나도록 '접는 부분'을 끼우고 뒷면에서 접어 모듈이 고정되도록 한다.

4.

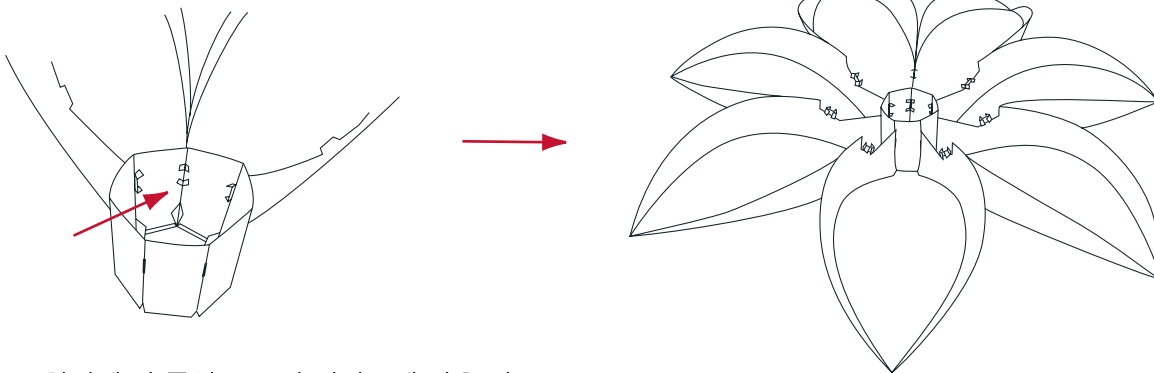

첫번째 갓 구성요소 옆 베이스에 다음 갓 구성요소를 끼우고 7개의 4번 전등갓 구성요소가 모두 끼워질 때까지 반복한다. 베이스 안에서 모듈을 고정하는 걸 잊지 않도록 한다.

5.

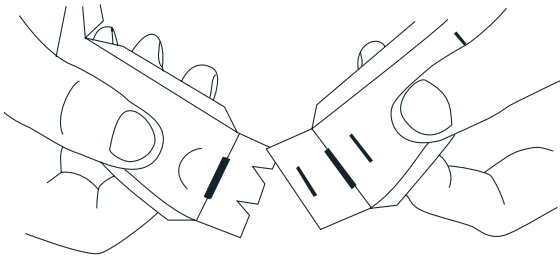

'L' 표시 링 구성요소를 집어 들고 강화 가장 자리를 접는다. '접는 부분'을 활용하여 링 구성요소를 조립한다.

6.

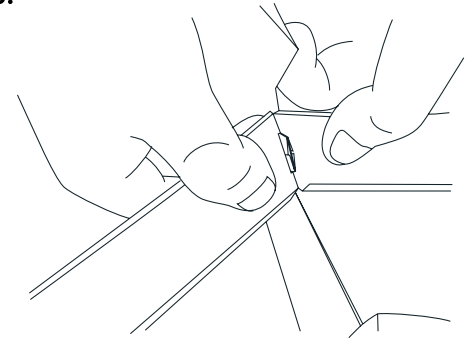

링 구성요소 'L'을 전등갓 구성요소의 '접는 부분' 위에 올리고 '접는 부분'을 펼쳐 고정한다.

7.

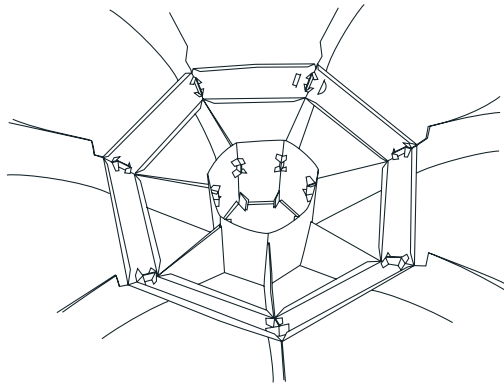

올바로 올려진 링 구성요소

8.

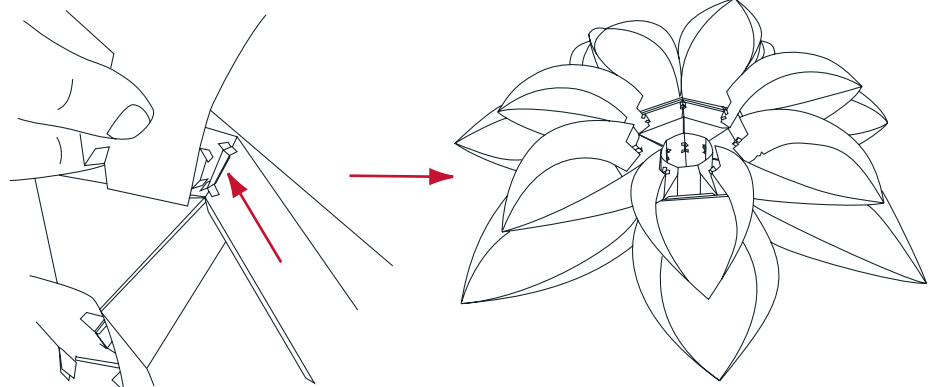

'3'번 전등갓 구성요소를 7개 접는다. 갓 구성요소의 곡선을 따라 조심스럽게 접는다. 다른 '접는 부분'들도 위치하고 있는 구멍을 지나도록 '접는 부분'을 밀어 링 구성요소 위에 첫번째 전등갓 구성요소를 올린다.

나머지 전등갓 구성요소도 비슷하게 모두 올린다. 뒷면에서 모듈을 고정하는 것을 잊지 않는다.

9.

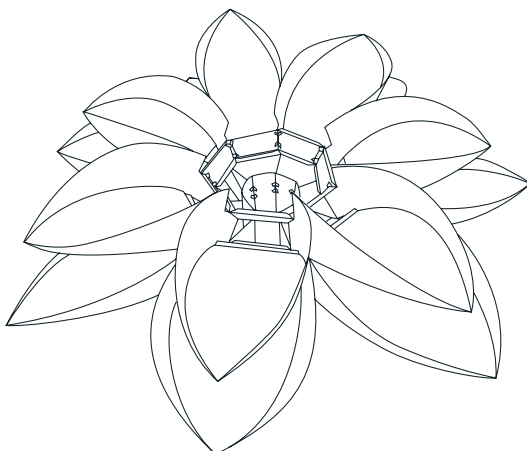

'3'번 전등갓 구성요소 위에 링 구성요소 'M'을 조립하고 올린다.

10.

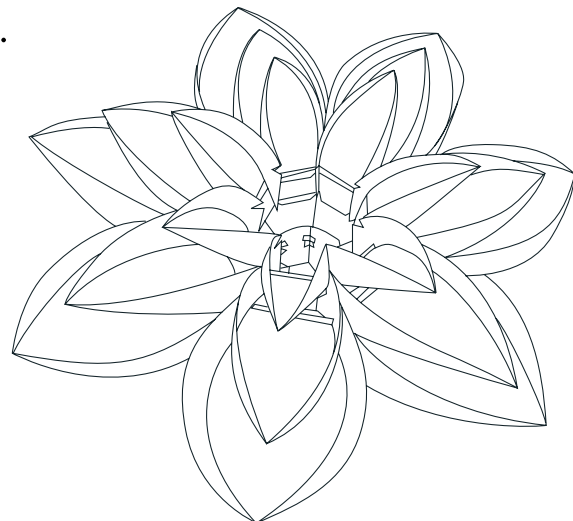

'2'번 전등갓 구성요소를 접고 링 구성요소 'M' 위에 모두 올린다. 링 구성요소 'S'를 올린다.

조립 안내 **NORM 06 LARGE**/한국어

11.

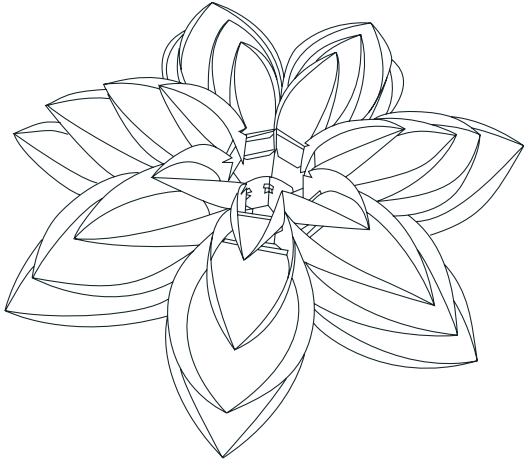

'1'번 전등갓 구성요소를 7개 접고 링 구성요소 'S' 위에 모두 올린다.

12.

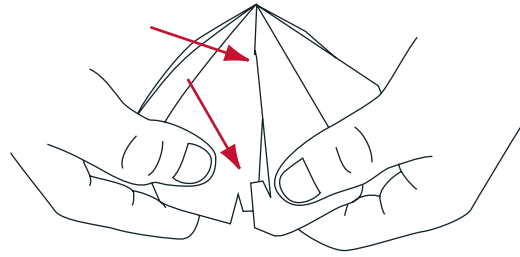

베이스 모듈을 구부려 조립한다. 접합 부분이 안쪽을 향하도록 한다.

13.

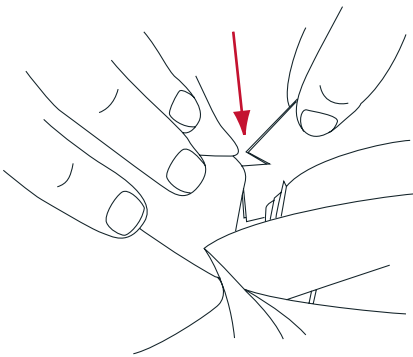

안쪽 전등갓 구성요소에 있는 홈에 베이스 모듈을 끼운다. (홈은 조그맣게 잘려져 있다.)

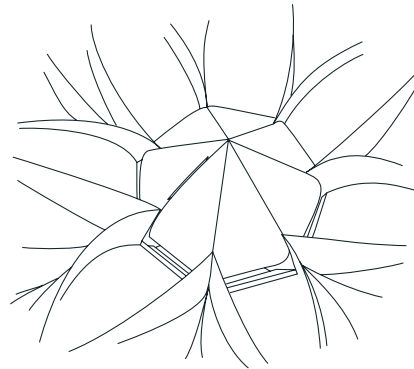

모두 조립된 베이스 모듈

14.

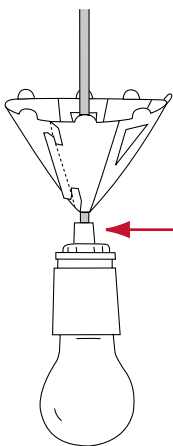

클램프 니플이 장착되어 있어야 한다.

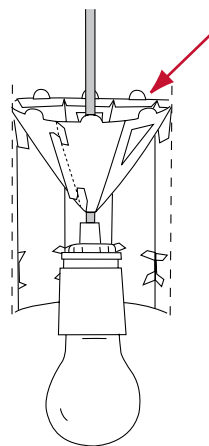

여섯 방향에서 매달기 모듈을 구부리고 7면 원뿔을 이루도록 철사 둘레를 조립한다.

전등의 상단에 있는 틈이 위쪽을 향하도록 전등을 돌린다. 매달기 모듈을 틈 안으로 내리고 구멍을 지나도록 '접는 부분'을 민다. 강화 가장자리를 수평으로 접어 매달기 모듈을 고정한다.

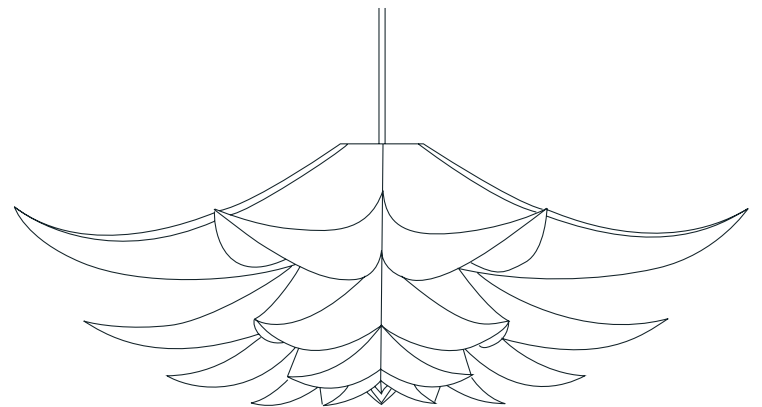

모두 조립되어 매달 수 있는 전등.조명 기구를 떼지 않고도 전등을 매달 수 있다. 유연한 전등 베이스를 통해 전구를 쉽게 갈아낄 수 있다.

**MAX 60 WATT**







**normann**

C O P E N H A G E N

Normann Copenhagen, Østerbrogade 70, 2100 Copenhagen Ø, Denmark, Tel. +45 35 55 44 59, Fax +45 35 55 44 39

[www.normann-copenhagen.com](http://www.normann-copenhagen.com)